

**310SJ and 410J  
Backhoe Loader  
with Total Machine  
Control (TMC)  
Repair**  
(Serial No. 161703 - )

**REPAIR TECHNICAL MANUAL**  
**310SJ and 410J Backhoe Loader with  
TMC (S.N. 161703— )**  
TM10853 20MAY19 (ENGLISH)

<https://johndeere.com/manuals/>

**Worldwide Construction  
And Forestry Division**  
PRINTED IN U.S.A.

# Introduction

## Foreword

This manual is written for an experienced technician. Essential tools required in performing certain service work are identified in this manual and are recommended for use.

Live with safety: Read the safety messages in the introduction of this manual and the cautions presented throughout the text of the manual.

 This is the safety-alert symbol. When you see this symbol on the machine or in this manual, be alert to the potential for personal injury.

Technical manuals are divided in two parts: repair and operation and tests. Repair sections tell how to repair the components. Operation and tests sections help you identify the majority of routine failures quickly.

Information is organized in groups for the various components requiring service instruction. At the beginning of each group are summary listings of all applicable essential tools, service equipment and tools, other materials needed to do the job, service parts kits, specifications, wear tolerances, and torque values.

Technical Manuals are concise guides for specific machines. They are on-the-job guides containing only the vital information needed for diagnosis, analysis, testing, and repair.

Fundamental service information is available from other sources covering basic theory of operation, fundamentals of troubleshooting, general maintenance, and basic type of failures and their causes.

TX03399,0001836 -19-22MAR12-1/1

<https://johndeere manual .cc>

### Technical Information Feedback Form

We need your help to continually improve our technical publications. Please copy this page and FAX or mail your comments, ideas and improvements.

**SEND TO:** John Deere Dubuque Works  
18600 South John Deere Road  
Attn: Publications, Dept. 324  
Dubuque, IA 52004-0538  
USA

**FAX NUMBER:** 1-563-589-5800 (USA)

Publication Number: \_\_\_\_\_

Page Number: \_\_\_\_\_

Ideas, Comments: \_\_\_\_\_  
\_\_\_\_\_  
\_\_\_\_\_  
\_\_\_\_\_  
\_\_\_\_\_  
\_\_\_\_\_  
\_\_\_\_\_  
\_\_\_\_\_  
\_\_\_\_\_  
\_\_\_\_\_  
\_\_\_\_\_  
\_\_\_\_\_  
\_\_\_\_\_  
\_\_\_\_\_  
\_\_\_\_\_  
\_\_\_\_\_  
\_\_\_\_\_  
\_\_\_\_\_  
\_\_\_\_\_  
\_\_\_\_\_  
\_\_\_\_\_

<https://johndeeremanual.com>

Name: \_\_\_\_\_

Phone: \_\_\_\_\_

Email Address: \_\_\_\_\_

**THANK YOU!**

TX,TM,FAX -19-03JUL01-1/1

<https://johndeere-manual.com>

# Contents

## Section 00—General Information

- Group 0001—Safety Information
- Group 0003—Torque Values

## Section 01—Wheels

- Group 0110—Powered or Non-Powered Wheels and Fastenings

## Section 02—Axles and Suspension Systems

- Group 0225—Input Drive Shafts and U-Joints
- Group 0230—Non-Powered Wheel Axles
- Group 0240—Powered Wheel Axle (MFWD)
- Group 0250—Axle Shaft, Bearings, and Reduction Gears

## Section 03—Transmission

- Group 0300—Removal and Installation
- Group 0315—Controls Linkage
- Group 0350—Gears, Shafts, and Power Shift Clutches
- Group 0360—Hydraulic System

## Section 04—Engine

- Group 0400—Removal and Installation

## Section 05—Engine Auxiliary Systems

- Group 0505—Cold Weather Starting Aid
- Group 0510—Cooling System
- Group 0515—Speed Controls
- Group 0520—Intake System
- Group 0530—Exhaust System
- Group 0560—External Fuel Supply System

## Section 06—Torque Converter

- Group 0651—Turbine, Gears and Shaft

## Section 09—Steering System

- Group 0960—Hydraulic System

## Section 10—Service Brakes

- Group 1011—Active Elements
- Group 1060—Hydraulic System

## Section 11—Park Brake

- Group 1111—Active Elements

## Section 17—Frame or Supporting Structure

- Group 1740—Frame Installation
- Group 1749—Chassis Weights

## Section 18—Operator's Station

- Group 1800—Removal and Installation
- Group 1810—Operator Enclosure
- Group 1821—Seat and Seat Belt
- Group 1830—Heating and Air Conditioning

## Section 19—Sheet Metal and Styling

- Group 1910—Hood and Engine Enclosure
- Group 1913—Miscellaneous Shields
- Group 1921—Grille and Grille Housing
- Group 1927—Fenders

## Section 20—Safety, Convenience and Miscellaneous

- Group 2001—Radio
- Group 2004—Horn and Warning Devices

## Section 21—Main Hydraulic System

- Group 2160—Hydraulic System

## Section 31—Loader

- Group 3100—Loader
- Group 3102—Bucket
- Group 3104—Attachment Coupler
- Group 3115—Control Linkages
- Group 3160—Hydraulic System

## Section 33—Backhoe

- Group 3302—Bucket
- Group 3315—Control Linkage
- Group 3340—Frames
- Group 3360—Hydraulic System

## Section 38—Grapple

- Group 3800—Hydraulic Thumb
- Group 3860—Hydraulic Thumb Cylinder

## Section 99—Dealer Fabricated Tools

- Group 9900—Dealer Fabricated Tools

*Original Instructions. All information, illustrations and specifications in this manual are based on the latest information available at the time of publication. The right is reserved to make changes at any time without notice.*

COPYRIGHT © 2019  
DEERE & COMPANY  
Moline, Illinois  
All rights reserved.  
A John Deere ILLUSTRATION™ Manual  
Previous Editions  
Copyright © 2008, 2009, 2010, 2011, 2012, 2013, 2014, 2015, 2016, 2018

<https://johndeere-manual.com>

## Section 00 General Information

### Contents

Page	Page
<b>Group 0001—Safety Information</b>	
Recognize Safety Information .....	00-0001-1
Follow Safety Instructions.....	00-0001-1
Operate Only If Qualified.....	00-0001-1
Wear Protective Equipment.....	00-0001-2
Avoid Unauthorized Machine Modifications.....	00-0001-2
Inspect Machine .....	00-0001-2
Stay Clear of Moving Parts.....	00-0001-2
Avoid High-Pressure Oils .....	00-0001-3
Avoid High-Pressure Fluids .....	00-0001-3
Beware of Exhaust Fumes .....	00-0001-4
Prevent Fires .....	00-0001-4
Prevent Battery Explosions .....	00-0001-4
Handle Chemical Products Safely.....	00-0001-5
Dispose of Waste Properly .....	00-0001-5
Prepare for Emergencies.....	00-0001-5
Use Steps and Handholds Correctly .....	00-0001-5
Start Only From Operator's Seat.....	00-0001-6
Use and Maintain Seat Belt.....	00-0001-6
Prevent Unintended Machine Movement.....	00-0001-6
Prevent Unintended Machine Movement—If Equipped With Pilot Controls .....	00-0001-6
Avoid Work Site Hazards.....	00-0001-7
Keep Riders Off Machine .....	00-0001-7
Avoid Backover Accidents.....	00-0001-8
Avoid Machine Tipover .....	00-0001-8
Add and Operate Attachments Safely.....	00-0001-8
Use Special Care When Operating.....	00-0001-9
Operating or Traveling On Public Roads .....	00-0001-9
Inspect and Maintain ROPS .....	00-0001-9
Prevent Unintended Detonation of Explosive Devices .....	00-0001-10
Park and Prepare for Service Safely.....	00-0001-10
Service Cooling System Safely .....	00-0001-10
Remove Paint Before Welding or Heating .....	00-0001-11
Make Welding Repairs Safely .....	00-0001-11
Drive Metal Pins Safely .....	00-0001-11
Service Tires Safely.....	00-0001-12
<b>Group 0003—Torque Values</b>	
Torque Value Metric Bolt and Cap Screw.....	00-0003-1
Additional Metric Cap Screw Torque Values.....	00-0003-2
Unified Inch Bolt and Cap Screw .....	00-0003-3
Service Recommendations for 37° Flare and 30° Cone Seat Connectors .....	00-0003-4
Service Recommendations for O-Ring Boss Fittings.....	00-0003-4
Service Recommendation O-Ring Boss Fittings In Aluminum HousingExcavators.....	00-0003-6
Service Recommendations for Flared Connections—Straight or Tapered Threads .....	00-0003-7
Service Recommendations For Flat Face O-Ring Seal Fittings .....	00-0003-8
O-Ring Face Seal Fittings with SAE Inch Hex Nut and Stud End for High Pressure.....	00-0003-9
O-Ring Face Seal Fittings with Metric Hex Nut and Stud End for Standard Pressure.....	00-0003-11
O-Ring Face Seal Fittings with Metric Hex Nut and Stud End for High Pressure.....	00-0003-13
Service Recommendations for Metric Series Four Bolt Flange Fitting.....	00-0003-15
Service Recommendations For Inch Series Four Bolt Flange Fittings .....	00-0003-16
Inch Series Four Bolt Flange Fitting For High Pressure Service Recommendations.....	00-0003-17
Service Recommendations For Non-Restricted Banjo (Adjustable) Fittings.....	00-0003-18
Service Recommendations For O-Ring Boss Fittings With Shoulder .....	00-0003-19
Metric 24 O-Ring Seal DIN 20078.....	00-0003-21

<https://johndeere-manual.com>



# Group 0001 Safety Information

## Recognize Safety Information

This is the safety alert symbol. When you see this symbol on your machine or in this manual, be alert for the potential of personal injury.

Follow the precautions and safe operating practices highlighted by this symbol.

A signal word — DANGER, WARNING, or CAUTION — is used with the safety alert symbol. DANGER identifies the most serious hazards.

On your machine, DANGER signs are red in color, WARNING signs are orange, and CAUTION signs are yellow. DANGER and WARNING signs are located near specific hazards. General precautions are on CAUTION labels.



T133555 —UN—15APR13

T133588 —19—28AUG00

TX03679,00016CC -19-08JAN18-1/1

## Follow Safety Instructions

Read the safety messages in this manual and on the machine. Follow these warnings and instructions carefully. Review them frequently. Keep safety signs in good condition. Replace missing or damaged safety signs. Be sure new equipment components and repair parts include the current safety signs. Replacement safety signs are available from your authorized John Deere dealer.

Be sure all operators of this machine understand every safety message. Replace operator's manual and safety labels immediately if missing or damaged.

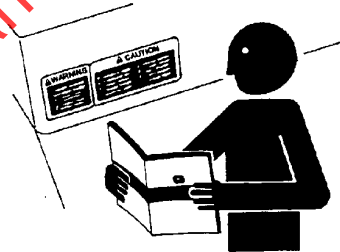

T133556 —UN—24AUG00

TX03679,00016F9 -19-07SEP06-1/1

## Operate Only If Qualified

Do not operate this machine unless the operator's manual has been read carefully, and you have been qualified by supervised training and instruction.

Operator should be familiar with the job site and surroundings before operating. Try all controls and

machine functions with the machine in an open area before starting to work.

Know and observe all safety rules that may apply to every work situation and work site.

TX03679,00016FA -19-03JAN07-1/1

## Safety Information

### Wear Protective Equipment

Guard against injury from flying pieces of metal or debris; wear goggles or safety glasses.

Wear close fitting clothing and safety equipment appropriate to the job.

Prolonged exposure to loud noise can cause impairment or loss of hearing. Wear suitable hearing protection such as earmuffs or earplugs to protect against objectionable or uncomfortable loud noises.

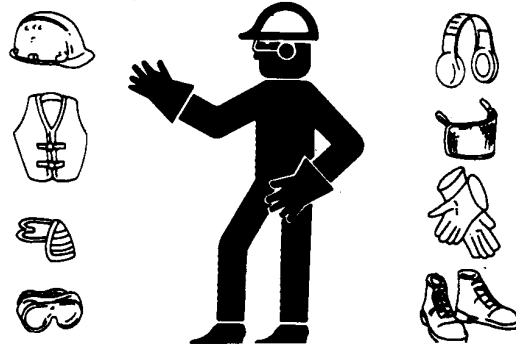

TS206—UN—15APR13

TX03679,00016D0 -19-05MAY10-1/1

### Avoid Unauthorized Machine Modifications

John Deere recommends using only genuine John Deere replacement parts to ensure machine performance. Never substitute genuine John Deere parts with alternate parts not intended for the application as these can create hazardous situations or hazardous performance. Non-John Deere Parts, or any damage or failures resulting from their use are not covered by any John Deere warranty.

Modifications of this machine, or addition of unapproved products or attachments, may affect machine stability or

reliability, and may create a hazard for the operator or others near the machine. The installer of any modification which may affect the electronic controls of this machine is responsible for establishing that the modification does not adversely affect the machine or its performance.

Always contact an authorized dealer before making machine modifications that change the intended use, weight or balance of the machine, or that alter machine controls, performance or reliability.

ER93822,0000030 -19-16FEB08-1/1

### Inspect Machine

Inspect machine carefully each day by walking around it before starting.

Keep all guards and shields in good condition and properly installed. Fix damage and replace worn or broken parts immediately. Pay special attention to hydraulic hoses and electrical wiring.



T6607AQ—UN—15APR13

TX03679,0001734 -19-08JAN08-1/1

### Stay Clear of Moving Parts

Entanglements in moving parts can cause serious injury.

Stop engine before examining, adjusting or maintaining any part of machine with moving parts.

Keep guards and shields in place. Replace any guard or shield that has been removed for access as soon as service or repair is complete.

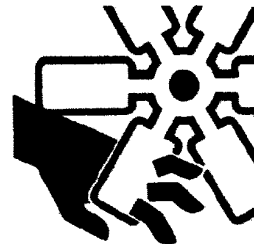

T133592—UN—15APR13

TX03679,00016D2 -19-08JAN08-1/1

### Avoid High-Pressure Oils

This machine uses a high-pressure hydraulic system. Escaping oil under pressure can penetrate the skin causing serious injury.

**Never search for leaks with your hands.** Protect hands. Use a piece of cardboard to find location of escaping oil. Stop engine and relieve pressure before disconnecting lines or working on hydraulic system.

**If hydraulic oil penetrates your skin, see a doctor immediately. Injected oil must be removed surgically within hours or gangrene may result.** Contact a knowledgeable medical source or the Deere & Company Medical Department in Moline, Illinois, U.S.A.

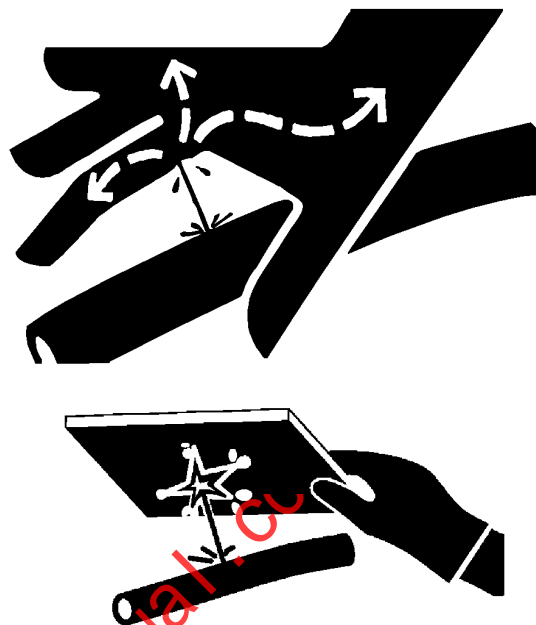

T133509—UN—15APR13

T133840—UN—20SEP00

TX03679,00016D3 -19-03NOV08-1/1

### Avoid High-Pressure Fluids

Inspect hydraulic hoses periodically – at least once per year – for leakage, kinking, cuts, cracks, abrasion, blisters, corrosion, exposed wire braid or any other signs of wear or damage.

Replace worn or damaged hose assemblies immediately with John Deere approved replacement parts.

Escaping fluid under pressure can penetrate the skin causing serious injury.

Avoid the hazard by relieving pressure before disconnecting hydraulic or other lines. Tighten all connections before applying pressure.

Search for leaks with a piece of cardboard. Protect hands and body from high-pressure fluids.

If an accident occurs, see a doctor immediately. Any fluid injected into the skin must be surgically removed within a few hours or gangrene may result. Doctors unfamiliar

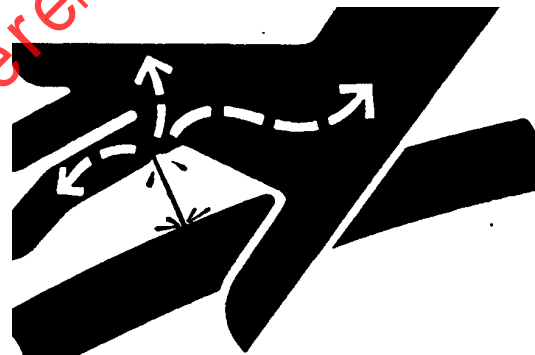

with this type of injury should reference a knowledgeable medical source. Such information is available in English from Deere & Company Medical Department in Moline, Illinois, U.S.A., by calling 1-800-822-8262 or +1 309-748-5636.

X9811—UN—23AUG88

DX,FLUID -19-12OCT11-1/1

## Safety Information

### Beware of Exhaust Fumes

Prevent asphyxiation. Engine exhaust fumes can cause sickness or death.

If you must operate in an enclosed space, provide adequate ventilation. Use an exhaust pipe extension to remove the exhaust fumes or open doors and windows to bring outside air into the area.

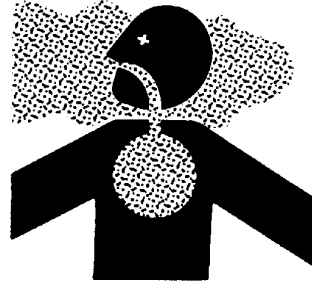

T133546 —UN—24AUG00

TX03679,00016D4 -19-23JUN08-1/1

### Prevent Fires

**Handle Fuel Safely:** Store flammable fluids away from fire hazards. Never refuel machine while smoking or when near sparks or flame.

**Clean Machine Regularly:** Keep trash, debris, grease and oil from accumulating in engine compartment, around fuel lines, hydraulic lines, exhaust components and electrical wiring. Never store oily rags or flammable materials inside a machine compartment.

**Maintain Hoses and Wiring:** Replace hydraulic hoses immediately if they begin to leak, and clean up any oil spills. Examine electrical wiring and connectors frequently for damage.

**Keep A Fire Extinguisher Available:** Always keep a multi-purpose fire extinguisher on or near the machine. Know how to use extinguisher properly.



T133553 —UN—07SEP00



T133554 —UN—07SEP00



T133552 —UN—15APR13

TX03679,00016F5 -19-26JUN09-1/1

### Prevent Battery Explosions

Battery gas can explode. Keep sparks, lighted matches, and open flame away from the top of battery.

Never check battery charge by placing a metal object across the posts. Use a voltmeter or hydrometer.

Do not charge a frozen battery; it may explode. Warm battery to 16°C (60°F).



TS204 —UN—15APR13

TX03679,000174A -19-08JAN08-1/1

## Safety Information

### Handle Chemical Products Safely

Exposure to hazardous chemicals can cause serious injury. Under certain conditions, lubricants, coolants, paints and adhesives used with this machine may be hazardous.

If uncertain about safe handling or use of these chemical products, contact your authorized dealer for a Material Safety Data Sheet (MSDS) or go to internet website <http://www.jdmsds.com>. The MSDS describes physical and health hazards, safe use procedures, and emergency response techniques for chemical substances. Follow

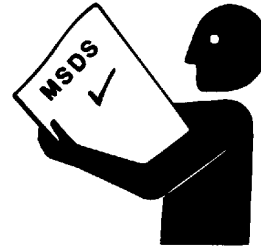

MSDS recommendations to handle chemical products safely.

TX03679,00016D7 -19-03JAN07-1/1

T133580 —UN—25AUG00

### Dispose of Waste Properly

Improper disposal of waste can threaten the environment. Fuel, oils, coolants, filters and batteries used with this machine may be harmful if not disposed of properly.

Never pour waste onto the ground, down a drain, or into any water source.

Air conditioning refrigerants can damage the atmosphere. Government regulations may require using a certified service center to recover and recycle used refrigerants.

If uncertain about the safe disposal of waste, contact your local environmental or recycling center or your authorized dealer for more information.

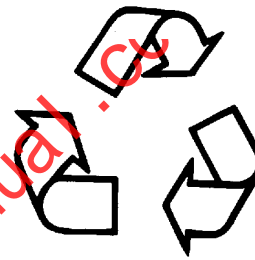

TX03679,0001733 -19-08JAN08-1/1

T133567 —UN—25AUG00

### Prepare for Emergencies

Be prepared if an emergency occurs or a fire starts.

Keep a first aid kit and fire extinguisher handy.

Keep emergency numbers for doctors, ambulance service, hospital, and fire department near your telephone.

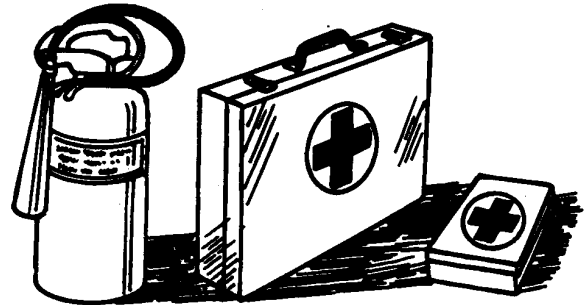

TX03679,000174B -19-08JAN08-1/1

TS291 —UN—15APR13

### Use Steps and Handholds Correctly

Prevent falls by facing the machine when you get on and off. Maintain 3-point contact with steps and handrails. Never use machine controls as handholds.

Use extra care when mud, snow, or moisture present slippery conditions. Keep steps clean and free of grease or oil. Never jump when exiting machine. Never mount or dismount a moving machine.

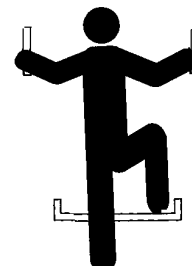

TX03679,00016F2 -19-12FEB07-1/1

T133468 —UN—15APR13

### Start Only From Operator's Seat

Avoid unexpected machine movement. Start engine only while sitting in operator's seat. Ensure all controls and working tools are in proper position for a parked machine.

Never attempt to start engine from the ground. Do not attempt to start engine by shorting across the starter solenoid terminals.



T133715—UN—15APR13

TX03679,0001799 -19-22APR10-1/1

### Use and Maintain Seat Belt

**Use seat belt when operating machine.** Remember to fasten seat belt when loading and unloading from trucks and during other uses.

Examine seat belt frequently. Be sure webbing is not cut or torn. Replace seat belt immediately if any part is damaged or does not function properly.

**The complete seat belt assembly should be replaced every three years, regardless of appearance.**



**USE  
SEAT  
BELT**

T133716—19—17APR13

TX03679,00016DD -19-19MAR07-1/1

### Prevent Unintended Machine Movement

**Always set the park lock brake switch to the ON position before leaving the operator's seat for any reason.**

Be careful not to accidentally actuate steering, travel or other controls. Engage park brake and lower work

equipment to the ground during work interruptions. Stop the engine before allowing anyone to approach the machine. Follow proper parking procedures before leaving the operator's station.

AM40430,00002E6 -19-06FEB07-1/1

### Prevent Unintended Machine Movement—If Equipped With Pilot Controls

Be careful not to accidentally actuate control levers when co-workers are present. Always lock hydraulics on

backhoe during work interruptions. Lock hydraulics before allowing anyone to approach machine.

AM40430,00002E5 -19-13JAN06-1/1

### Avoid Work Site Hazards

**Avoid contact with gas lines, buried cables and water lines. Call utility line location services to identify all underground utilities before you dig.**

**Prepare work site properly.** Avoid operating near structures or objects that could fall onto the machine. Clear away debris that could move unexpectedly if run over.

**Avoid boom or attachment contact with overhead obstacles or overhead electrical lines.** Never move any part of machine or load closer than 3 m (10 ft) plus twice the line insulator length to overhead wires.

**Keep bystanders clear at all times.** Keep bystanders away from raised booms, attachments, and unsupported loads. Avoid swinging or raising booms, attachments, or loads over or near personnel. Use barricades or a signal person to keep vehicles and pedestrians away. Use a signal person if moving machine in congested areas or where visibility is restricted. Always keep signal person in view. Coordinate hand signals before starting machine.

**Operate only on solid footing** with strength sufficient to support machine. Be especially alert working near embankments or excavations.

**Avoid working under over-hanging embankments or stockpiles** that could collapse on machine.

**Reduce machine speed** when operating with tool on or near ground when obstacles may be hidden (e.g., during snow removal or clearing mud, dirt, etc.). At high speeds hitting obstacles (rocks, uneven concrete or manholes) can cause a sudden stop. Always wear your seat belt.

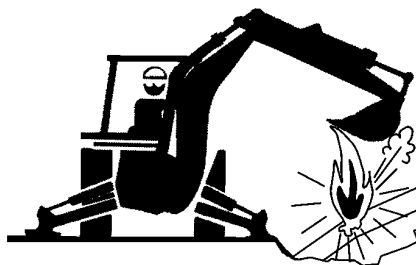

T147554—UN—01NOV01

T147555—UN—13DEC01

TX03768,0000BAA -19-01APR10-1/1

### Keep Riders Off Machine

Only allow the operator on the machine. Keep riders off.

Riders on machine are subject to injury such as being struck by foreign objects and being thrown off of the machine. Riders also obstruct the operator's view resulting in the machine being operated in an unsafe manner.

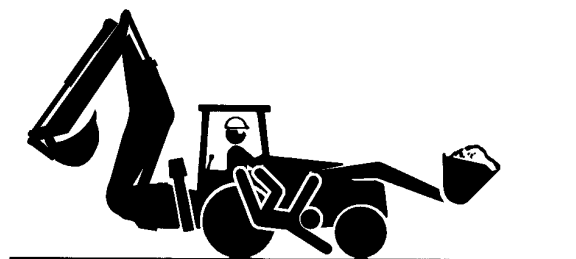

T148715—UN—06DEC01

TX03768,0000BAF -19-27MAR09-1/1

### Avoid Backover Accidents

**Before moving machine, be sure all persons are clear of the machine travel path.** Turn around and look directly for best visibility. Use mirror to assist in checking behind the machine. Keep windows and mirror clean and in good repair.

**Be certain backup warning alarm is working properly.**

**Use a signal person when backing if view is obstructed or when in close quarters.** Keep signal person in view at all times. Use prearranged hand signals to communicate.



T145317—UN—06SEP01

TX03768.0000B8B -19-20DEC06-1/1

### Avoid Machine Tipover

**Use seat belt at all times.**

**Do not jump if the machine tips.** You will be unlikely to jump clear and the machine may crush you.

**Load and unload from trucks or trailers carefully.** Be sure truck is wide enough and secured on a firm level surface. Use loading ramps and attach them properly to truck bed.

**Be careful on slopes.** Use extra care on soft, rocky or frozen ground because machine may slip sideways in these conditions.

**Ensure solid footing.** Use extra care when operating on stockpile materials, or near banks or excavations that may cave-in and cause machine to tip or fall.

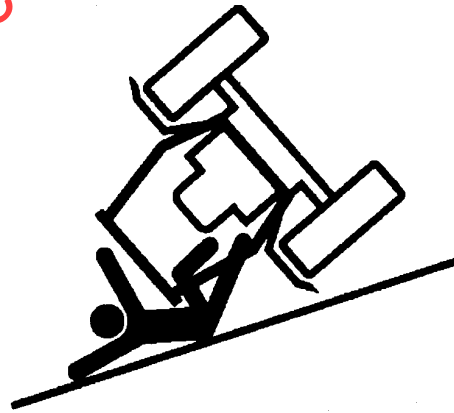

T147495—19—26OCT01

TX03768.0000BA3 -19-07SEP06-1/1

### Add and Operate Attachments Safely

Always verify compatibility of attachments by contacting your authorized dealer. Adding unapproved attachments may affect machine stability or reliability and may create a hazard for others near the machine.

Ensure that a qualified person is involved in attachment installation. Add guards to machine if operator protection

is required or recommended. Verify that all connections are secure and attachment responds properly to controls.

Carefully read attachment manual and follow all instructions and warnings. In an area free of bystanders and obstructions, carefully operate attachment to learn its characteristics and range of motion.

TX03679.00016F0 -19-12FEB07-1/1



### Use Special Care When Operating

**Never use the loader to lift people.** Do not allow anyone to ride in the bucket or use the bucket as a work platform.

**Operate carefully with raised loads.** Raising the load reduces machine stability, especially on side slopes or soft terrain. Drive and turn slowly with a raised load.

**Ensure that objects in the bucket are secure.** Do not attempt to lift or carry objects that are too big or too long to fit inside the bucket unless secured with an adequate chain or other device. Keep bystanders away from raised loads.

**Be careful when lifting objects.** Never attempt to lift objects too heavy for your machine. Assure machine stability and hydraulic capability with a test lift before attempting other maneuvers. Use an adequate chain or sling and proper rigging techniques to attach and stabilize loads.

**Never lift an object above or near another person.**

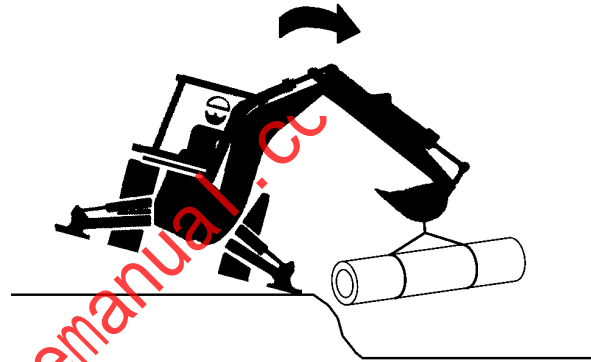

T148749—UN—05DEC01

T147438—UN—26OCT01

TX03768,0000B70 -19-27MAR09-1/1

### Operating or Traveling On Public Roads

Machines that work near vehicle traffic or travel slower than normal highway speeds must have proper lighting and markings to assure they are visible to other drivers.

Install additional lights, beacons, slow moving vehicle (SMV) emblems, or other devices and use as required to make the machine visible and identify it as a work machine. Check state and local regulations to assure compliance. Keep these devices clean and in working condition.

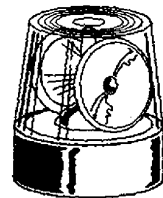
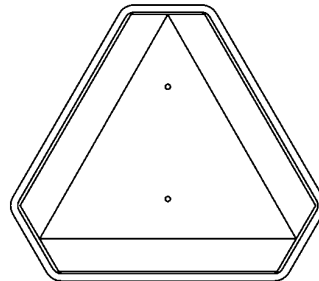

T141891—UN—15APR13

TX03679,00017C8 -19-02MAR07-1/1

### Inspect and Maintain ROPS

A damaged roll-over protective structure (ROPS) should be replaced, not reused.

The protection offered by ROPS will be impaired if ROPS is subjected to structural damage, is involved in an overturn incident, or is in any way altered by welding, bending, drilling, or cutting.

If ROPS was loosened or removed for any reason, inspect it carefully before operating the machine again.

To maintain the ROPS:

- Replace missing hardware using correct grade hardware.
- Check hardware torque.
- Check isolation mounts for damage, looseness or wear; replace them if necessary.
- Check ROPS for cracks or physical damage.

TX03679,000179F -19-07SEP06-1/1

### Prevent Unintended Detonation of Explosive Devices

Avoid serious injury or death from an explosion hazard. Deactivate all cellular or radio frequency devices on equipment stored or operating in an area, such as a blasting zone, where the use of radio transmitting devices are prohibited.

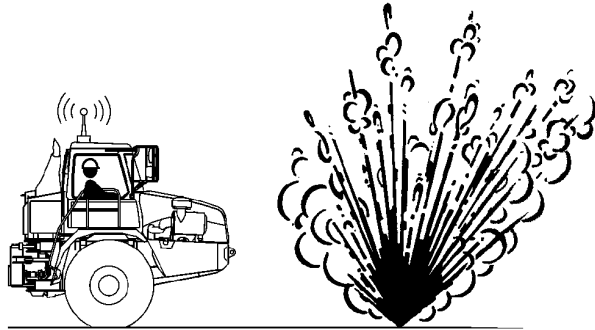

TX1023216 -JUN-07MAY07

VD76477,0001543 -19-08JAN08-1/1

### Park and Prepare for Service Safely

**Warn others of service work.** Always park and prepare your machine for service or repair properly.

- Park machine on a level surface and lower equipment to the ground.
- Engage park brake.
- Stop engine and remove key.
- Attach a “Do Not Operate” tag in an obvious place in the operator’s station.

Securely support machine or attachment before working under it.

- Do not support machine with any hydraulically actuated tools or attachments.
- Do not support machine with cinder blocks or wooden pieces that may crumble or crush.
- Do not support machine with a single jack or other devices that may slip out of place.
- Always install boom lock before working on or around this machine with the loader boom raised.

Understand service procedures before beginning repairs. Keep service area clean and dry. Use two people whenever the engine must be running for service work.

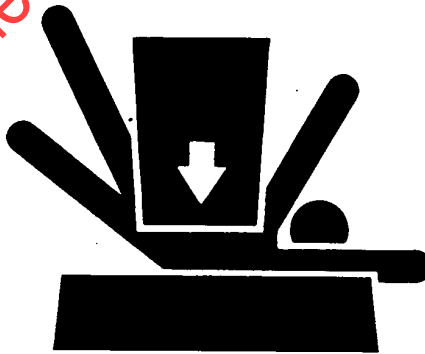

T133332 -19-17APR13

TS229 -JUN-23AUG88

TX03679,0001809 -19-02MAR07-1/1

### Service Cooling System Safely

Explosive release of fluids from pressurized cooling system can cause serious burns.

Do not service radiator through the radiator cap. Only fill through the surge tank filler cap. Shut off engine. Only remove surge tank filler cap when cool enough to touch with bare hands. Slowly loosen cap to relieve pressure before removing completely.



TS281 -JUN-15APR13

TX,SURGE -19-19JAN11-1/1

### Remove Paint Before Welding or Heating

Avoid potentially toxic fumes and dust.

Hazardous fumes can be generated when paint is heated by welding, soldering, or using a torch.

Remove paint before heating:

- Remove paint a minimum of 100 mm (4 in.) from area to be affected by heating. If paint cannot be removed, wear an approved respirator before heating or welding.
- If you sand or grind paint, avoid breathing the dust. Wear an approved respirator.
- If you use solvent or paint stripper, remove stripper with soap and water before welding. Remove solvent or paint stripper containers and other flammable material from area. Allow fumes to disperse at least 15 minutes before welding or heating.

Do not use a chlorinated solvent in areas where welding will take place.



Do all work in an area that is well ventilated to carry toxic fumes and dust away.

Dispose of paint and solvent properly.

DX,PAINT -19-24JUL02-1/1

TS220—UN—15APR13

### Make Welding Repairs Safely

**IMPORTANT: Disable electrical power before welding. Turn off main battery switch or disconnect positive battery cable. Separate harness connectors to engine and vehicle microprocessors.**

Avoid welding or heating near pressurized fluid lines. Flammable spray may result and cause severe burns if pressurized lines fail as a result of heating. Do not let heat go beyond work area to nearby pressurized lines.

Remove paint properly. Do not inhale paint dust or fumes. Use a qualified welding technician for structural repairs.

Make sure there is good ventilation. Wear eye protection and protective equipment when welding.



TX03679,00016D5 -19-24SEP07-1/1

T133547—UN—15APR13

### Drive Metal Pins Safely

Always wear protective goggles or safety glasses and other protective equipment before striking hardened parts. Hammering hardened metal parts such as pins and bucket teeth may dislodge chips at high velocity.

Use a soft hammer or a brass bar between hammer and object to prevent chipping.

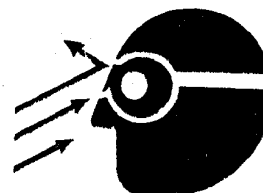

TX03679,0001745 -19-07SEP06-1/1

T133738—UN—15APR13

### Service Tires Safely

Explosive separation of a tire and rim parts can cause serious injury or death.

Do not attempt to mount a tire unless you have the proper equipment and experience to perform the job.

Always maintain the correct tire pressure. Do not inflate the tires above the recommended pressure. Never weld or heat a wheel and tire assembly. The heat can cause an increase in air pressure resulting in a tire explosion. Welding can structurally weaken or deform the wheel.

When inflating tires, use a clip-on chuck and extension hose long enough to allow you to stand to one side and NOT in front of or over the tire assembly. Use a safety cage if available.

Check wheels for low pressure, cuts, bubbles, damaged rims or missing lug bolts and nuts.

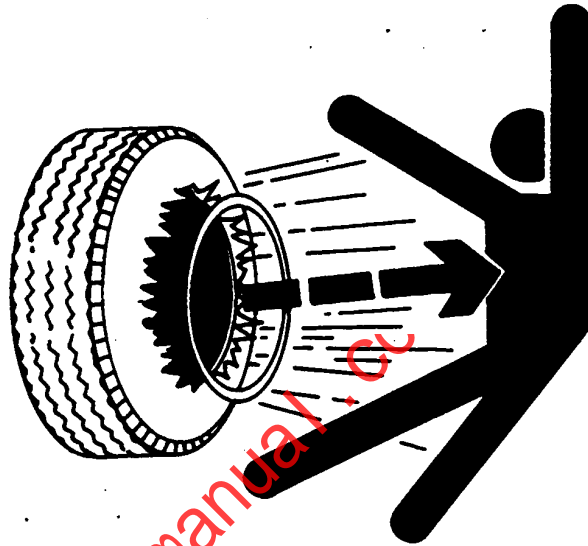

TS211—UN—15APR13

DX,RIM -19-24AUG90-1/1

<https://johndeere.com/manuals>

# Group 0003 Torque Values

TOR02—UN—15APR13

## Metric Bolt and Cap Screw Torque Values

METRIC BOLT AND CAP SCREW TORQUE VALUES—Tolerance is  $\pm 10\%$  unless otherwise specified

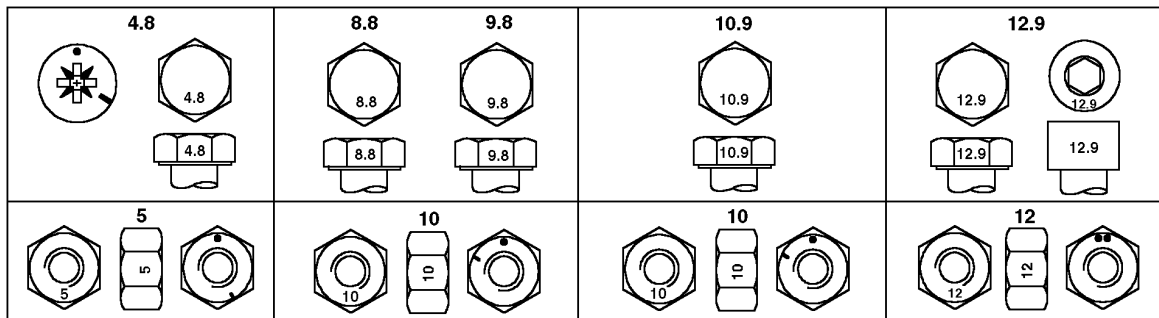

Top—Property Class and Head Markings; Bottom—Property Class and Nut Markings

Thread Size	Class 4.8		Class 8.8 or 9.8		Class 10.9		Class 12.9	
	Lubricated <sup>a</sup> Nm (lb-ft)	Dry <sup>b</sup> Nm (lb-ft)	Lubricated <sup>a</sup> Nm (lb-ft)	Dry <sup>b</sup> Nm (lb-ft)	Lubricated <sup>a</sup> Nm (lb-ft)	Dry <sup>b</sup> Nm (lb-ft)	Lubricated <sup>a</sup> Nm (lb-ft)	Dry <sup>b</sup> Nm (lb-ft)
M6	4.7 (3.5)	6 (4.4)	9 (6.6)	11.5 (8.5)	13 (9.5)	16.5 (12.2)	15.5 (11.5)	19.5 (14.5)
M8	11.5 (8.5)	14.5 (10.7)	22 (16)	28 (20.5)	32 (23.5)	40 (29.5)	37 (27.5)	47 (35)
M10	23 (17)	29 (21)	43 (32)	55 (40)	63 (46)	80 (59)	75 (55)	95 (70)
M12	40 (29.5)	50 (37)	75 (55)	95 (70)	110 (80)	140 (105)	130 (95)	165 (120)
M14	63 (46)	80 (59)	120 (88)	150 (110)	175 (130)	220 (165)	205 (150)	260 (190)
M16	100 (74)	125 (92)	190 (140)	240 (175)	275 (200)	350 (255)	320 (235)	400 (300)
M18	135 (100)	170 (125)	265 (195)	330 (245)	375 (275)	475 (350)	440 (325)	560 (410)
M20	190 (140)	245 (180)	375 (275)	475 (350)	530 (390)	675 (500)	625 (460)	790 (580)
M22	265 (195)	330 (245)	510 (375)	650 (480)	725 (535)	920 (680)	850 (625)	1080 (800)
M24	330 (245)	425 (315)	650 (480)	820 (600)	920 (680)	1150 (850)	1080 (800)	1350 (1000)
M27	490 (360)	625 (460)	950 (700)	1200 (885)	1350 (1000)	1700 (1250)	1580 (1160)	2000 (1475)
M30	660 (490)	850 (625)	1290 (950)	1630 (1200)	1850 (1350)	2300 (1700)	2140 (1580)	2700 (2000)
M33	900 (665)	1150 (850)	1750 (1300)	2200 (1625)	2500 (1850)	3150 (2325)	2900 (2150)	3700 (2730)
M36	1150 (850)	1450 (1075)	2250 (1650)	2850 (2100)	3200 (2350)	4050 (3000)	3750 (2770)	4750 (3500)

<sup>a</sup> "Lubricated" means coated with a lubricant such as engine oil, or fasteners with phosphate and oil coatings.

<sup>b</sup> "Dry" means plain or zinc plated without any lubrication.

**CAUTION:** Use only metric tools on metric hardware. Other tools may not fit properly. Tool may slip and cause injury.

DO NOT use these values if a different torque value or tightening procedure is given for a specific application. Torque values listed are for general use only. Check tightness of fasteners periodically.

Shear bolts are designed to fail under predetermined loads. Always replace shear bolts with identical property class.

Fasteners should be replaced with the same or higher property class. If higher property class fasteners are used, these should only be tightened to the strength of the original.

Make sure fastener threads are clean and that you properly start thread engagement. This will prevent them from failing when tightening.

Tighten plastic insert or crimped steel-type lock nuts to approximately 50 percent of the dry torque shown in the chart, applied to the nut, not to the bolt head. Tighten toothed or serrated-type lock nuts to the full torque value.

OUT3035,TORQUE2 -19-22MAR04-1/1

### Additional Metric Cap Screw Torque Values

**⚠ CAUTION:** Use only metric tools on metric hardware. Other tools may not fit properly. They may slip and cause injury.

Check tightness of cap screws periodically. Torque values listed are for general use only. Do not use these values if a different torque value or tightening procedure is listed for a specific application.

Shear bolts are designed to fail under predetermined loads. Always replace shear bolts with identical grade.

Fasteners should be replaced with the same or higher grade. If higher grade fasteners are used, these should only be tightened to the strength of the original.

Make sure fastener threads are clean and that the thread engagement is properly started. This will prevent fasteners from failing when tightening.

Tighten cap screws having lock nuts to approximately 50 percent of amount shown in chart.

METRIC CAP SCREW TORQUE VALUES <sup>a</sup>						
Nominal Diameter	T-Bolt		H-Bolt		M-Bolt	
	N·m	lb·ft	N·m	lb·ft	N·m	lb·ft
8	29	21	20	15	10	7
10	63	46	45	33	20	15
12	108	80	88	65	34	25
14	176	130	137	101	54	40
16	265	195	206	152	78	58
18	392	289	294	217	118	87
20	539	398	392	289	167	125
22	735	542	539	398	216	159
24	931	687	686	506	274	202
27	1372	1012	1029	759	392	289
30	1911	1410	1421	1049	539	398
33	2548	1890	1911	1410	735	542
36	3136	2314	2401	1772	931	687

<sup>a</sup>Torque tolerance is ±10%.

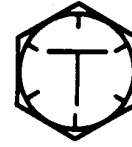

T6873AA

T-Bolt



T6873AB

H-Bolt



T6873AC

M-Bolt

T6873AA —JUN—15APR13

T6873AB —JUN—18OCT88

T6873AC —JUN—18OCT88

## Torque Values

### Unified Inch Bolt and Cap Screw Torque Values

UNIFIED INCH BOLT AND CAP SCREW TORQUE VALUES—Tolerance is  $\pm 10\%$  unless otherwise specified

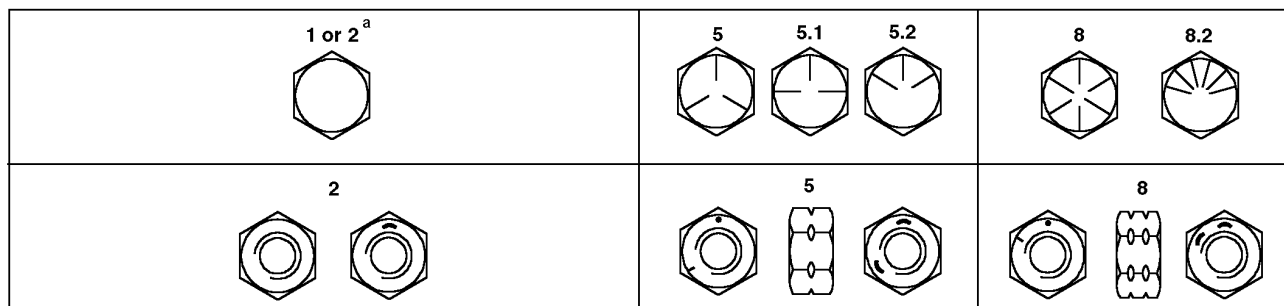

Top—SAE Grade and Head Markings; Bottom—SAE Grade and Nut Markings

Thread Size	Grade 1 (No Mark)		Grade 2 <sup>a</sup> (No Mark)		Grade 5, 5.1 or 5.2		Grade 8 or 8.2	
	Lubricated <sup>b</sup> N·m (lb-ft)	Dry <sup>c</sup> N·m (lb-ft)	Lubricated <sup>b</sup> N·m (lb-ft)	Dry <sup>c</sup> N·m (lb-ft)	Lubricated <sup>b</sup> N·m (lb-ft)	Dry <sup>c</sup> N·m (lb-ft)	Lubricated <sup>b</sup> N·m (lb-ft)	Dry <sup>c</sup> N·m (lb-ft)
1/4	3.8 (2.8)	4.7 (3.5)	6 (4.4)	7.5 (5.5)	9.5 (7)	12 (9)	13.5 (10)	17 (12.5)
5/16	7.7 (5.7)	9.8 (7.2)	12 (9)	15.5 (11.5)	19.5 (14.5)	25 (18.5)	28 (20.5)	35 (26)
3/8	13.5 (10)	17.5 (13)	22 (16)	27.5 (20)	35 (26)	44 (32.5)	49 (36)	63 (46)
7/16	22 (16)	28 (20.5)	35 (26)	44 (32.5)	56 (41)	70 (52)	80 (59)	100 (74)
1/2	34 (25)	42 (31)	53 (39)	67 (49)	85 (63)	110 (80)	120 (88)	155 (115)
9/16	48 (35.5)	60 (45)	76 (56)	95 (70)	125 (92)	155 (115)	175 (130)	220 (165)
5/8	67 (49)	85 (63)	105 (77)	135 (100)	170 (125)	215 (160)	240 (175)	305 (225)
3/4	120 (88)	150 (110)	190 (140)	240 (175)	300 (220)	380 (280)	425 (315)	540 (400)
7/8	190 (140)	240 (175)	190 (140)	240 (175)	490 (360)	615 (455)	690 (510)	870 (640)
1	285 (210)	360 (265)	285 (210)	360 (265)	730 (540)	920 (680)	1030 (760)	1300 (960)
1-1/8	400 (300)	510 (375)	400 (300)	510 (375)	910 (670)	1150 (850)	1450 (1075)	1850 (1350)
1-1/4	570 (420)	725 (535)	570 (420)	725 (535)	1280 (945)	1630 (1200)	2050 (1500)	2600 (1920)
1-3/8	750 (550)	950 (700)	750 (550)	950 (700)	1700 (1250)	2140 (1580)	2700 (2000)	3400 (2500)
1-1/2	990 (730)	1250 (930)	990 (730)	1250 (930)	2250 (1650)	2850 (2100)	3600 (2650)	4550 (3350)

<sup>a</sup> Grade 2 applies for hex cap screws (not hex bolts) up to 6 in. (152 mm) long. Grade 1 applies for hex cap screws over 6 in. (152 mm) long, and for all other types of bolts and screws of any length.

<sup>b</sup> "Lubricated" means coated with a lubricant such as engine oil, or fasteners with phosphate and oil coatings.

<sup>c</sup> "Dry" means plain or zinc plated without any lubrication.

DO NOT use these values if a different torque value or tightening procedure is given for a specific application. Torque values listed are for general use only. Check tightness of fasteners periodically.

Shear bolts are designed to fail under predetermined loads. Always replace shear bolts with identical grade.

Fasteners should be replaced with the same or higher grade. If higher grade fasteners are used, these should only be tightened to the strength of the original.

Make sure fastener threads are clean and that you properly start thread engagement. This will prevent them from failing when tightening.

Tighten plastic insert or crimped steel-type lock nuts to approximately 50 percent of the dry torque shown in the chart, applied to the nut, not to the bolt head. Tighten toothed or serrated-type lock nuts to the full torque value.

OUT3035,TORQUE1 -19-14JAN04-1/1

TORQ1A—UN—15APR13

## Torque Values

### Service Recommendations for 37° Flare and 30° Cone Seat Connectors

1. Inspect flare and flare seat. They must be free of dirt or obvious defects.
2. Defects in tube flare cannot be repaired. Overtightening a defective flared fitting will not stop leaks.
3. Align tube with fitting before attempting to start nut.
4. Lubricate male threads with hydraulic fluid or petroleum jelly.
5. Index angle fittings and tighten by hand.
6. Tighten fitting or nut to torque value shown on torque chart. Do not allow hoses to twist when tightening fittings.



Cone Seat Connector

STRAIGHT FITTING OR SPECIAL NUT TORQUE CHART		
Thread Size	N·m	lb·ft
3/8 - 24 UNF	8	6
7/16 - 20 UNF	12	9
1/2 - 20 UNF	16	12
9/16 - 18 UNF	24	18
3/4 - 16 UNF	46	34
7/8 - 14 UNF	62	46
1-1/16 - 12 UN	102	75
1-3/16 - 12 UN	122	90
1-5/16 - 12 UN	142	105
1-7/8 - 12	190	140
1-7/8 - 12 UN	217	160

NOTE: Torque tolerance is  $\pm 10\%$ .

T82,BHMA,EL -19-29SEP99-1/1

T6234AC — UN — 15APR13

### Service Recommendations for O-Ring Boss Fittings

#### Straight Fitting

1. Inspect O-ring boss seat for dirt or defects.
2. Lubricate O-ring with petroleum jelly. Place electrical tape over threads to protect O-ring. Slide O-ring over tape and into O-ring groove of fitting. Remove tape.
3. Tighten fitting to torque value shown on chart.

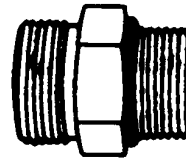

Continued on next page

AA95137,0001435 -19-02APR08-1/2

T6243AE — UN — 15APR13