

# **35D and 50D Excavator Repair**

**TECHNICAL MANUAL**  
**35D and 50D Excavator Repair**  
TM2264 17JUL18 (ENGLISH)

**Worldwide Construction  
And Forestry Division**  
PRINTED IN U.S.A.

# Introduction

## Foreword

This manual is written for an experienced technician. Essential tools required in performing certain service work are identified in this manual and are recommended for use.

Live with safety: Read the safety messages in the introduction of this manual and the cautions presented throughout the text of the manual.

 This is the safety-alert symbol. When you see this symbol on the machine or in this manual, be alert to the potential for personal injury.

Technical manuals are divided in two parts: repair and operation and tests. Repair sections tell how to repair the components. Operation and tests sections help you identify the majority of routine failures quickly.

Information is organized in groups for the various components requiring service instruction. At the beginning of each group are summary listings of all applicable essential tools, service equipment and tools, other materials needed to do the job, service parts kits, specifications, wear tolerances, and torque values.

Technical Manuals are concise guides for specific machines. They are on-the-job guides containing only the vital information needed for diagnosis, analysis, testing, and repair.

Fundamental service information is available from other sources covering basic theory of operation, fundamentals of troubleshooting, general maintenance, and basic type of failures and their causes.

DX,TMIFC -19-15APR14-1/1

**Technical Information Feedback Form**

We need your help to continually improve our technical publications. Please copy this page and FAX or mail your comments, ideas and improvements.

**SEND TO:** John Deere Dubuque Works  
18600 South John Deere Road  
Attn: Publications, Dept. 324  
Dubuque, IA 52004-0538  
USA

**FAX NUMBER:** 1-563-589-5800 (USA)

Publication Number: \_\_\_\_\_

Page Number: \_\_\_\_\_

Ideas, Comments: \_\_\_\_\_  
\_\_\_\_\_  
\_\_\_\_\_  
\_\_\_\_\_  
\_\_\_\_\_  
\_\_\_\_\_  
\_\_\_\_\_  
\_\_\_\_\_  
\_\_\_\_\_  
\_\_\_\_\_  
\_\_\_\_\_  
\_\_\_\_\_  
\_\_\_\_\_  
\_\_\_\_\_  
\_\_\_\_\_  
\_\_\_\_\_

Name: \_\_\_\_\_

Phone: \_\_\_\_\_

Email Address: \_\_\_\_\_

**THANK YOU!**

TX, TM, FAX -19-03JUL01-1/1

*Introduction*

# Contents

## **Section 00—General Information**

- Group 0001—Safety
- Group 0003—Torque Values

## **Section 01—Tracks**

- Group 0130—Track System

## **Section 02—Axles and Suspension Systems (Travel)**

- Group 0250—Axle Shaft, Bearings, and Reduction Gears
- Group 0260—Hydraulic System

## **Section 04—Engine**

- Group 0400—Removal and Installation

## **Section 05—Engine Auxiliary Systems**

- Group 0510—Cooling System
- Group 0560—External Fuel Supply Systems

## **Section 17—Frame or Supporting Structure**

- Group 1740—Frame Installation
- Group 1749—Chassis Weights

## **Section 18—Operators Station**

- Group 1800—Removal and Installation
- Group 1810—Operator Enclosure
- Group 1821—Seat and Seat Belt
- Group 1830—Heating and Air Conditioning System

## **Section 32—Bulldozers (Blade)**

- Group 3201—Blades
- Group 3260—Hydraulic System

## **Section 33—Excavator**

- Group 3302—Buckets
- Group 3340—Frames
- Group 3360—Hydraulic System

## **Section 43—Swing or Pivoting System**

- Group 4350—Mechanical Drive Elements
- Group 4360—Hydraulic System

## **Section 99—Dealer Fabricated Tools**

- Group 9900—Dealer Fabricated Tools

*Original Instructions. All information, illustrations and specifications in this manual are based on the latest information available at the time of publication. The right is reserved to make changes at any time without notice.*

COPYRIGHT © 2018  
DEERE & COMPANY  
Moline, Illinois  
All rights reserved.  
A John Deere ILLUSTRATION™ Manual  
Previous Editions  
Copyright © 2009, 2010, 2011, 2012, 2013, 2014, 2015, 2016, 2017

*Contents*

**Section 00**  
**General Information**

**Contents**

	Page		Page
<b>Group 0001—Safety</b>			
Recognize Safety Information .....	00-0001-1	Service Recommendations for	
Follow Safety Instructions.....	00-0001-1	37° Flare and 30° Cone Seat	
Operate Only If Qualified .....	00-0001-1	Connectors .....	00-0003-7
Wear Protective Equipment.....	00-0001-2	Service Recommendations for	
Avoid Unauthorized Machine		Flared Connections—Straight or	
Modifications.....	00-0001-2	Tapered Threads .....	00-0003-8
Add Cab Guarding for Special		Service Recommendations For	
Uses .....	00-0001-2	Inch Series Four Bolt Flange	
Inspect Machine .....	00-0001-2	Fittings .....	00-0003-9
Stay Clear of Moving Parts.....	00-0001-3	Service Recommendations for	
Avoid High-Pressure Fluids.....	00-0001-3	Metric Series Four Bolt Flange	
Avoid High-Pressure Oil .....	00-0001-4	Fitting.....	00-0003-10
Beware of Exhaust Fumes .....	00-0001-4		
Prevent Fires .....	00-0001-5		
Prevent Battery Explosions .....	00-0001-5		
Handle Chemical Products Safely.....	00-0001-5		
Dispose of Waste Properly .....	00-0001-6		
Prepare for Emergencies.....	00-0001-6		
Use Steps and Handholds			
Correctly .....	00-0001-6		
Start Only From Operator's Seat.....	00-0001-6		
Use and Maintain Seat Belt.....	00-0001-7		
Prevent Unintended Machine			
Movement.....	00-0001-7		
Avoid Work Site Hazards.....	00-0001-8		
Keep Riders Off Machine .....	00-0001-8		
Avoid Backover Accidents .....	00-0001-9		
Avoid Machine Tip Over .....	00-0001-9		
Use Special Care When Lifting			
Objects .....	00-0001-10		
Add and Operate Attachments			
Safely.....	00-0001-10		
Park and Prepare for Service			
Safely.....	00-0001-10		
Service Cooling System Safely .....	00-0001-11		
Remove Paint Before Welding or			
Heating .....	00-0001-11		
Make Welding Repairs Safely .....	00-0001-11		
Drive Metal Pins Safely .....	00-0001-12		
 <b>Group 0003—Torque Values</b>			
Torque Value			
Metric Bolt and Cap Screw.....	00-0003-1		
Additional Metric Cap Screw			
Torque Values.....	00-0003-2		
Unified Inch Bolt and Cap Screw .....	00-0003-3		
Check Oil Lines and Fittings.....	00-0003-4		
Service Recommendations for			
O-Ring Boss Fittings.....	00-0003-4		
Service Recommendations For			
Flat Face O-Ring Seal Fittings .....	00-0003-6		

*Contents*



### Recognize Safety Information

This is the safety alert symbol. When this symbol is noticed on the machine or in this manual, be alert for the potential of personal injury.

Follow the precautions and safe operating practices highlighted by this symbol.

A signal word — DANGER, WARNING, or CAUTION — is used with the safety alert symbol. DANGER identifies the most serious hazards.

On the machine, DANGER signs are red in color, WARNING signs are orange, and CAUTION signs are yellow. DANGER and WARNING signs are located near specific hazards. General precautions are on CAUTION labels.



TX03679,00016CC -19-03JAN07-1/1

T133555 —UN—15APR13

T133588 —19—28AUG00

### Follow Safety Instructions

Read the safety messages in this manual and on the machine. Follow these warnings and instructions carefully. Review them frequently.

Be sure all operators of this machine understand every safety message. Replace operator's manual and safety labels immediately if missing or damaged.



TX03679,00016F9 -19-03JAN07-1/1

T133556 —UN—24AUG00

### Operate Only If Qualified

Do not operate this machine unless the operator's manual has been read carefully, and you have been qualified by supervised training and instruction.

Operator should be familiar with the job site and surroundings before operating. Try all controls and

machine functions with the machine in an open area before starting to work.

Know and observe all safety rules that may apply to every work situation and work site.

TX03679,00016FA -19-03JAN07-1/1

### Wear Protective Equipment

Guard against injury from flying pieces of metal or debris; wear goggles or safety glasses.

Wear close fitting clothing and safety equipment appropriate to the job.

Prolonged exposure to loud noise can cause impairment or loss of hearing. Wear suitable hearing protection such as earmuffs or earplugs to protect against objectionable or uncomfortable loud noises.

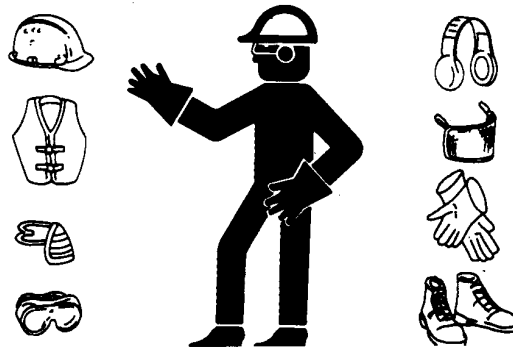

TS206—UN—15APR13

TX03679,00016D0 -19-03JAN07-1/1

### Avoid Unauthorized Machine Modifications

John Deere recommends using only genuine John Deere replacement parts to ensure machine performance. Never substitute genuine John Deere parts with alternate parts not intended for the application as these can create hazardous situations or hazardous performance. Non-John Deere parts, or any damage or malfunctions resulting from their use, are not covered by any John Deere warranty.

Modifications of this machine, or addition of unapproved products or attachments, may affect machine stability or

reliability, and may create a hazard for the operator or others near the machine. The installer of any modification which may affect the electronic controls of this machine is responsible for establishing that the modification does not adversely affect the machine or its performance.

Always contact an authorized dealer before making machine modifications that change the intended use, weight or balance of the machine, or that alter machine controls, performance, or reliability.

AM40430,00000A9 -19-01JUL15-1/1

### Add Cab Guarding for Special Uses

Special work situations or machine attachments may create an environment with falling or flying objects. Working near an overhead bank, doing demolition work, using a hydraulic hammer, or working in a wooded area, for example, may require added guarding to protect the operator.

FOPS (falling object protective structures) and special screens or guarding should be installed when falling or flying objects may enter or damage the machine. Contact your authorized dealer for information on devices intended to provide protection in special work situations.

TX14740,0001EF3 -19-25JAN07-1/1

### Inspect Machine

Inspect machine carefully each day by walking around it before starting.

Inspect and Clean the Polycarbonate Windows. See Inspect and Clean Polycarbonate Windows. (Section 4-1.)

Keep all guards and shields in good condition and properly installed. Fix damage and replace worn or broken parts immediately. Pay special attention to hydraulic hoses and electrical wiring.



T6607AC—UN—15APR13

TX03679,0001734 -19-17DEC14-1/1

### Stay Clear of Moving Parts

Entanglements in moving parts can cause serious injury.

Stop engine before examining, adjusting or maintaining any part of machine with moving parts.

Keep guards and shields in place. Replace any guard or shield that has been removed for access as soon as service or repair is complete.

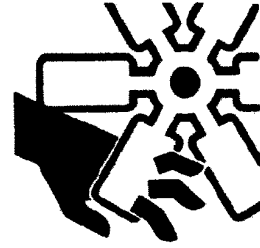

T133592 —UN—15APR13

TX03679,00016D2 -19-03JAN07-1/1

### Avoid High-Pressure Fluids

This machine uses a high-pressure hydraulic system. Escaping fluid under pressure can penetrate the skin causing serious injury.

**Never search for leaks with your hands.** Protect hands. Use a piece of cardboard to find location of escaping fluid. Stop engine and relieve pressure before disconnecting lines or working on hydraulic system.

**If hydraulic oil penetrates your skin, see a doctor immediately. Injected oil must be removed surgically within hours or gangrene may result.** Contact a knowledgeable medical source or the Deere & Company Medical Department in Moline, Illinois, U.S.A.

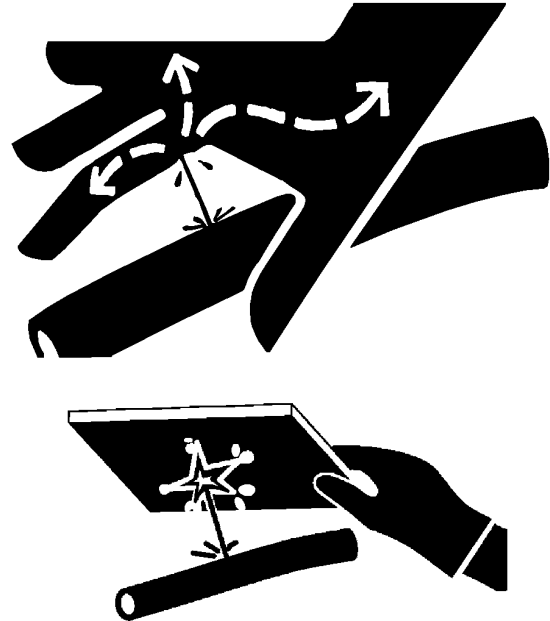

T133509 —UN—15APR13

T133840 —UN—20SEP00

TX03679,00016D3 -19-29JUN06-1/1

### Avoid High-Pressure Oil

This machine uses a high-pressure hydraulic system. Escaping oil under pressure can penetrate the skin causing serious injury.

**Never search for leaks with your hands.** Protect hands. Use a piece of cardboard to find location of escaping oil. Stop engine and relieve pressure before disconnecting lines or working on hydraulic system.

**If hydraulic oil penetrates your skin, see a doctor immediately. Injected oil must be removed surgically within hours or gangrene may result.** Contact a knowledgeable medical source or the Deere & Company Medical Department in Moline, Illinois, U.S.A.

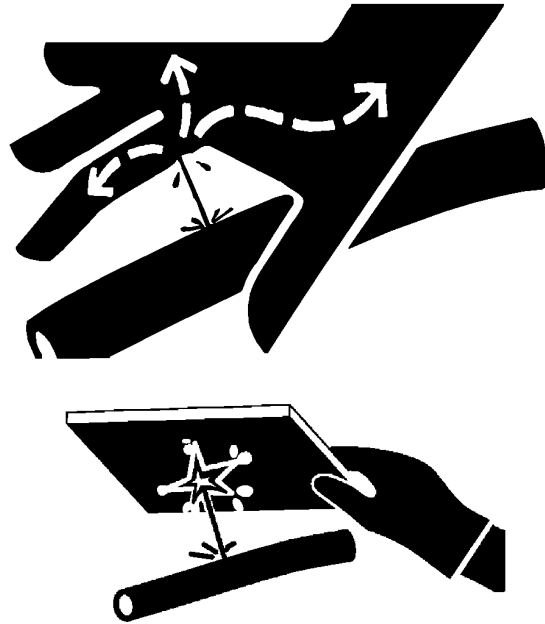

T133509 —UN—15APR13

T133840 —UN—20SEP00

DW90712,000038C -19-14NOV06-1/1

### Beware of Exhaust Fumes

Prevent asphyxiation. Engine exhaust fumes can cause sickness or death.

If you must operate in an enclosed space, provide adequate ventilation. Use an exhaust pipe extension to remove the exhaust fumes or open doors and windows to bring outside air into the area.

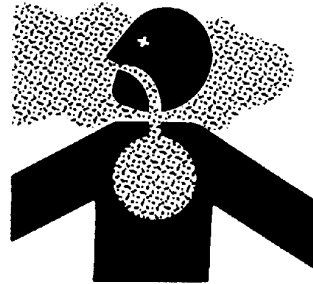

T133546 —UN—24AUG00

TX03679,00016D4 -19-03NOV08-1/1

### Prevent Fires

**Handle Fuel Safely:** Store flammable fluids away from fire hazards. Never refuel machine while smoking or when near sparks or flame.

**Clean Machine Regularly:** Keep trash, debris, grease and oil from accumulating in engine compartment, around fuel lines, hydraulic lines, exhaust components, and electrical wiring. Never store oily rags or flammable materials inside a machine compartment.

**Maintain Hoses and Wiring:** Replace hydraulic hoses immediately if they begin to leak, and clean up any oil spills. Examine electrical wiring and connectors frequently for damage.

**Keep A Fire Extinguisher Available:** Always keep a multipurpose fire extinguisher on or near the machine. Know how to use extinguisher properly.



T133553 —UN—07SEP00



T133554 —UN—07SEP00



TX03679,00016F5 -19-03NOV08-1/1

T133552 —UN—15APR13

### Prevent Battery Explosions

Battery gas can explode. Keep sparks, lighted matches, and open flame away from the top of battery.

Never check battery charge by placing a metal object across the posts. Use a voltmeter or hydrometer.

Do not charge a frozen battery; it may explode. Warm battery to 16°C (60°F).



TX03679,000174A -19-03NOV08-1/1

TS204 —UN—15APR13

### Handle Chemical Products Safely

Exposure to hazardous chemicals can cause serious injury. Under certain conditions, lubricants, coolants, paints and adhesives used with this machine may be hazardous.

If uncertain about safe handling or use of these chemical products, contact your authorized dealer for a Material Safety Data Sheet (MSDS) or go to internet website <http://www.jdmsds.com>. The MSDS describes physical and health hazards, safe use procedures, and emergency response techniques for chemical substances. Follow

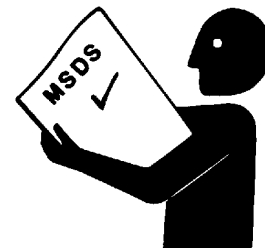

MSDS recommendations to handle chemical products safely.

TX03679,00016D7 -19-03JAN07-1/1

T133580 —UN—25AUG00

### Dispose of Waste Properly

Improper disposal of waste can threaten the environment. Fuel, oils, coolants, filters and batteries used with this machine may be harmful if not disposed of properly.

Never pour waste onto the ground, down a drain, or into any water source.

Air conditioning refrigerants can damage the atmosphere. Government regulations may require using a certified service center to recover and recycle used refrigerants.

If uncertain about the safe disposal of waste, contact your local environmental or recycling center or your authorized dealer for more information.

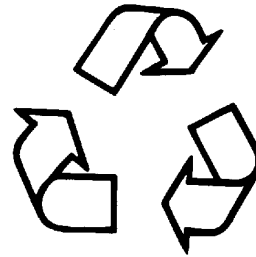

T133567 —UN—25AUG00

TX03679,0001733 -19-03JAN07-1/1

### Prepare for Emergencies

Be prepared if an emergency occurs or a fire starts.

Keep a first aid kit and fire extinguisher handy.

Keep emergency numbers for doctors, ambulance service, hospital, and fire department near your telephone.

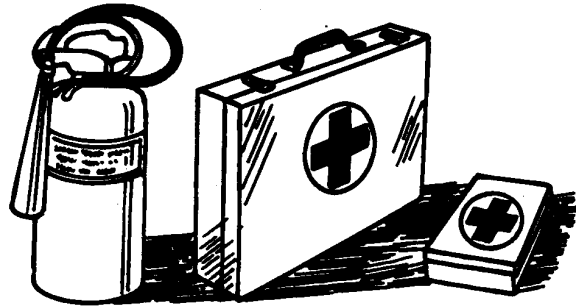

TS291 —UN—15APR13

TX03679,000174B -19-03JAN07-1/1

### Use Steps and Handholds Correctly

Prevent falls by facing the machine when getting on and off. Maintain 3-point contact with steps and handrails. Never use machine controls as handholds.

Use extra care when mud, snow, or moisture present slippery conditions. Keep steps clean and free of grease or oil. Never jump when exiting machine. Never mount or dismount a moving machine.

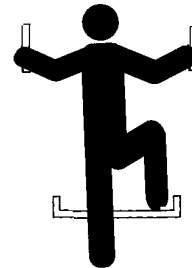

T133468 —UN—15APR13

TX03679,00016F2 -19-24APR13-1/1

### Start Only From Operator's Seat

Avoid unexpected machine movement. Start engine only while sitting in operator's seat. Ensure all controls and working tools are in proper position for a parked machine.

Never attempt to start engine from the ground. Do not attempt to start engine by shorting across the starter solenoid terminals.



T133715 —UN—15APR13

TX03679,0001799 -19-22APR10-1/1

### Use and Maintain Seat Belt

**Use seat belt when operating machine.** Remember to fasten seat belt when loading and unloading from trucks and during other uses.

Examine seat belt frequently. Be sure webbing is not cut or torn. Replace seat belt immediately if any part is damaged or does not function properly.

**The complete seat belt assembly should be replaced every 3 years, regardless of appearance.**



# USE SEAT BELT

T133716 —19—17APR13

TX03679,00016DD -19-03NOV08-1/1

### Prevent Unintended Machine Movement

Be careful not to accidentally actuate control levers when co-workers are present. Pull pilot control shutoff lever (1) to locked position during work interruptions. Pull pilot control shutoff lever to locked position and stop engine before allowing anyone to approach machine.

Always lower work equipment to the ground and pull pilot control shutoff lever to locked position before standing up or leaving the operator's seat. Stop engine before exiting.

- 1— Pilot Control Shutoff Lever    3— Pilot Control Levers  
2— Console

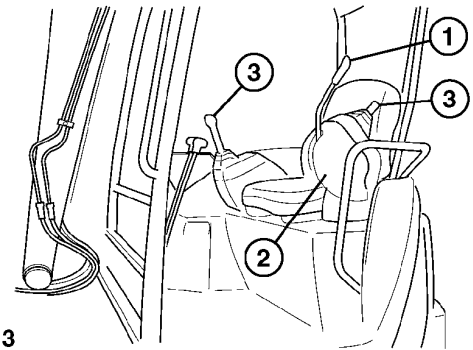

T204913

T204913 —UN—03DEC04

OOU1032,00015D1 -19-25JAN07-1/1

### Avoid Work Site Hazards

**Avoid contact with gas lines, buried cables, and water lines. Call utility line location services to identify all underground utilities before digging.**

**Prepare work site properly.** Avoid operating near structures or objects that could fall onto the machine. Clear away debris that could move unexpectedly if run over.

**Avoid boom or arm contact with overhead obstacles or overhead electrical lines.** Never move any part of machine or load closer than 3 m (10 ft) plus twice the line insulator length to overhead wires.

**Keep bystanders clear at all times.** Keep bystanders away from raised booms, attachments, and unsupported loads. Avoid swinging or raising booms, attachments, or loads over or near bystanders. Use barricades or a signal person to keep vehicles and pedestrians away. Use a signal person if moving machine in congested areas or where visibility is restricted. Always keep signal person in view. Coordinate hand signals before starting machine.

**Operate only on solid footing** with strength sufficient to support machine. When working close to an excavation, position travel motors away from the hole.

**Reduce machine speed** when operating with tool on or near ground when obstacles may be hidden (e.g., during snow removal or clearing mud, dirt, etc). At high speeds, hitting obstacles (rocks, uneven concrete, or manholes) can cause a sudden stop. Always wear seat belt.

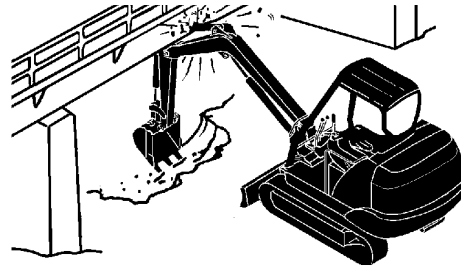
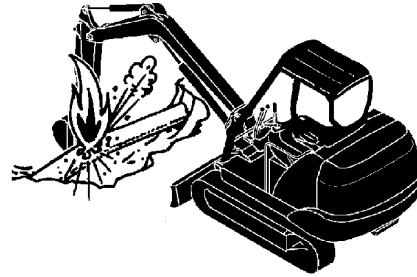

T153094 —UN—01APR02

T153096 —UN—01APR02

T153097 —UN—01APR02

VD76477,0000136 -19-27FEB17-1/1

### Keep Riders Off Machine

Only allow operator on machine.

Riders are subject to injury. They may fall from machine, be caught between machine parts, or be struck by foreign objects.

Riders may obstruct operator's view or impair his ability to operate machine safely.



T120807

T120807 —UN—14APR99

TX14740,0001E7A -19-19MAR02-1/1



### Avoid Backover Accidents

**Before moving machine, be sure all persons are clear of both travel and swing paths.** Turn around and look directly for best visibility. Keep windows clean, adjusted, and in good repair.

**Be certain travel alarm is working properly.**

**Use a signal person when backing if view is obstructed or when in close quarters.** Keep signal person in view at all times. Use prearranged hand signals to communicate.

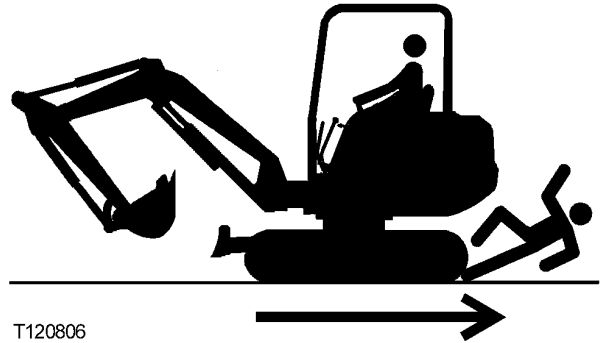

T120806

OUO1032,00015D0 -19-25JAN07-1/1

T120806 —UN—14APR99

### Avoid Machine Tip Over

**Use seat belt at all times.**

**Do not jump if the machine tips.** Operator will be unlikely to jump clear and the machine may crush the operator.

**Load and unload from trucks or trailers carefully.** Be sure truck is wide enough and on a firm level surface. Use loading ramps and attach them properly to truck bed. Avoid trucks with steel beds because tracks slip more easily on steel.

**Be careful on slopes.** Use extra care on soft, rocky or frozen ground. Machine may slip sideways in these conditions. When traveling up or down slopes, keep the bucket on uphill side and just above ground level.

**Be careful with heavy loads.** Using oversize buckets or lifting heavy objects reduces machine stability. Extending a heavy load or swinging it over side of undercarriage may cause machine to tip.

**Ensure solid footing.** Use extra care when operating near banks or excavations that may cave-in and cause machine to tip or fall.



**USE  
SEAT  
BELT**

Use Seat Belt

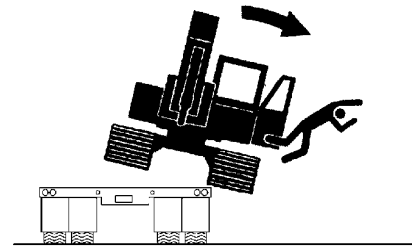

Unloading Machine

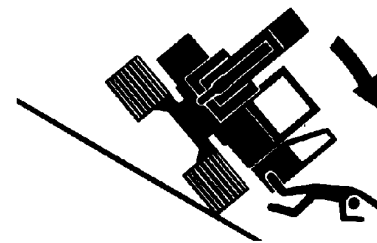

Do Not Jump

TX03679,00016DF -19-30JUN16-1/1

T133716 —19—17APR13

T133545 —UN—15SEP00

T133803 —UN—27SEP00

### Use Special Care When Lifting Objects

Never use this machine to lift people.

Never lift a load above another person. Keep bystanders clear of all areas where a load might fall if it breaks free. Do not leave the seat when there is a raised load.

Do not exceed lift capacity limits posted on machine and in this manual. Extending heavy loads too far or swinging over undercarriage side may cause machine to tip over.

Use proper rigging to attach and stabilize loads. Be sure slings or chains have adequate capacity and are in good condition. Use tether lines to guide loads and prearranged hand signals to communicate with co-workers.

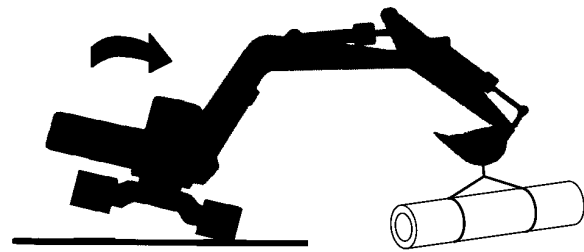

Use Special Care When Lifting Objects

T133839 —UN—27SEP00

TX03679,00016E1 -19-08JUL15-1/1

### Add and Operate Attachments Safely

Always verify compatibility of attachments by contacting your authorized dealer. Adding unapproved attachments may affect machine stability or reliability and may create a hazard for others near the machine.

Ensure that a qualified person is involved in attachment installation. Add guards to machine if operator protection

is required or recommended. Verify that all connections are secure and attachment responds properly to controls.

Carefully read attachment manual and follow all instructions and warnings. In an area free of bystanders and obstructions, carefully operate attachment to learn its characteristics and range of motion.

TX03679,00016F0 -19-12FEB07-1/1

### Park and Prepare for Service Safely

**Warn others of service work.** Always park and prepare your machine for service or repair properly.

- Park machine on a level surface and lower equipment and attachments to the ground.
- Place pilot shutoff lever in “lock” position. Stop engine and remove key.
- Attach a “Do Not Operate” tag in an obvious place in the operator’s station.

Securely support machine or attachment before working under it.

- Do not support machine with boom, arm, or other hydraulically actuated attachments.
- Do not support machine with cinder blocks or wooden pieces that may crumble or crush.
- Do not support machine with a single jack or other devices that may slip out of place.

Understand service procedures before beginning repairs. Keep service area clean and dry. Use two people whenever the engine must be running for service work.

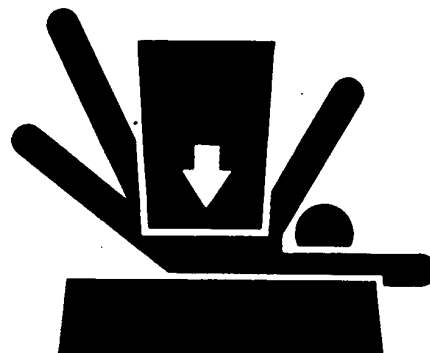
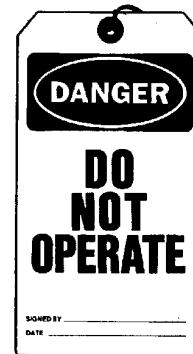

T133332 —19—17APR13

TS229 —UN—23AUG88

TX03679,00016E9 -19-03JAN07-1/1

### Service Cooling System Safely

Explosive release of fluids from pressurized cooling system can cause serious burns.

Shut off engine. Only remove filler cap when cool enough to touch with bare hands. Slowly loosen cap to first stop to relieve pressure before removing completely.

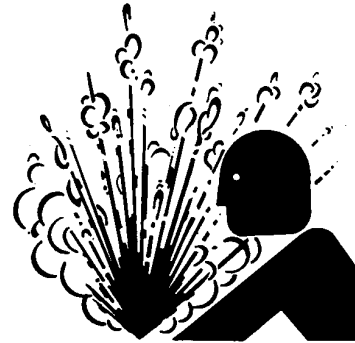

DX,RCAP -19-04JUN90-1/1

TS281 —UN—15APR13

### Remove Paint Before Welding or Heating

Avoid potentially toxic fumes and dust.

Hazardous fumes can be generated when paint is heated by welding, soldering, or using a torch.

Remove paint before heating:

- Remove paint a minimum of 100 mm (4 in.) from area to be affected by heating. If paint cannot be removed, wear an approved respirator before heating or welding.
- If you sand or grind paint, avoid breathing the dust. Wear an approved respirator.
- If you use solvent or paint stripper, remove stripper with soap and water before welding. Remove solvent or paint stripper containers and other flammable material from area. Allow fumes to disperse at least 15 minutes before welding or heating.

Do not use a chlorinated solvent in areas where welding will take place.

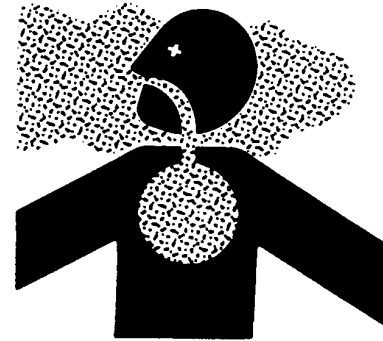

Do all work in an area that is well ventilated to carry toxic fumes and dust away.

Dispose of paint and solvent properly.

DX,PAINT -19-24JUL02-1/1

TS220 —UN—15APR13

### Make Welding Repairs Safely

**IMPORTANT: Disable electrical power before welding. Turn off main battery switch or disconnect positive battery cable. Separate harness connectors to engine and vehicle microprocessors.**

Avoid welding or heating near pressurized fluid lines. Flammable spray may result and cause severe burns if pressurized lines fail as a result of heating. Do not let heat go beyond work area to nearby pressurized lines.

Remove paint properly. Do not inhale paint dust or fumes. Use a qualified welding technician for structural repairs.



Make sure there is good ventilation. Wear eye protection and protective equipment when welding.

OUC1032,00015DD -19-06OCT09-1/1

T133547 —UN—15APR13

### Drive Metal Pins Safely

Always wear protective goggles or safety glasses and other protective equipment before striking hardened parts. Hammering hardened metal parts such as pins and bucket teeth may dislodge chips at high velocity.

Use a soft hammer or a brass bar between hammer and object to prevent chipping.

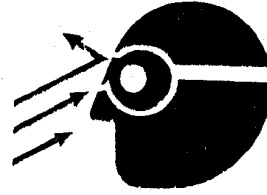

T133738—UN—15APR13

TX03679,0001745 -19-03JAN07-1/1

## Metric Bolt and Cap Screw Torque Values

METRIC BOLT AND CAP SCREW TORQUE VALUES—Tolerance is  $\pm 10\%$  unless otherwise specified

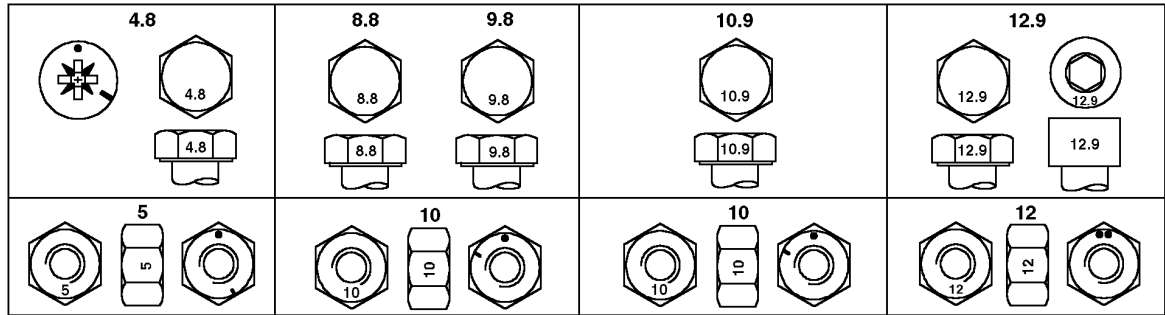

Top—Property Class and Head Markings; Bottom—Property Class and Nut Markings

Thread Size	Class 4.8		Class 8.8 or 9.8		Class 10.9		Class 12.9	
	Lubricated <sup>a</sup> Nm (lb-ft)	Dry <sup>b</sup> Nm (lb-ft)	Lubricated <sup>a</sup> Nm (lb-ft)	Dry <sup>b</sup> Nm (lb-ft)	Lubricated <sup>a</sup> Nm (lb-ft)	Dry <sup>b</sup> Nm (lb-ft)	Lubricated <sup>a</sup> Nm (lb-ft)	Dry <sup>b</sup> Nm (lb-ft)
M6	4.7 (3.5)	6 (4.4)	9 (6.6)	11.5 (8.5)	13 (9.5)	16.5 (12.2)	15.5 (11.5)	19.5 (14.5)
M8	11.5 (8.5)	14.5 (10.7)	22 (16)	28 (20.5)	32 (23.5)	40 (29.5)	37 (27.5)	47 (35)
M10	23 (17)	29 (21)	43 (32)	55 (40)	63 (46)	80 (59)	75 (55)	95 (70)
M12	40 (29.5)	50 (37)	75 (55)	95 (70)	110 (80)	140 (105)	130 (95)	165 (120)
M14	63 (46)	80 (59)	120 (88)	150 (110)	175 (130)	220 (165)	205 (150)	260 (190)
M16	100 (74)	125 (92)	190 (140)	240 (175)	275 (200)	350 (255)	320 (235)	400 (300)
M18	135 (100)	170 (125)	265 (195)	330 (245)	375 (275)	475 (350)	440 (325)	560 (410)
M20	190 (140)	245 (180)	375 (275)	475 (350)	530 (390)	675 (500)	625 (460)	790 (580)
M22	265 (195)	330 (245)	510 (375)	650 (480)	725 (535)	920 (680)	850 (625)	1080 (800)
M24	330 (245)	425 (315)	650 (480)	820 (600)	920 (680)	1150 (850)	1080 (800)	1350 (1000)
M27	490 (360)	625 (460)	950 (700)	1200 (885)	1350 (1000)	1700 (1250)	1580 (1160)	2000 (1475)
M30	660 (490)	850 (625)	1290 (950)	1630 (1200)	1850 (1350)	2300 (1700)	2140 (1580)	2700 (2000)
M33	900 (665)	1150 (850)	1750 (1300)	2200 (1625)	2500 (1850)	3150 (2325)	2900 (2150)	3700 (2730)
M36	1150 (850)	1450 (1075)	2250 (1650)	2850 (2100)	3200 (2350)	4050 (3000)	3750 (2770)	4750 (3500)

<sup>a</sup> "Lubricated" means coated with a lubricant such as engine oil, or fasteners with phosphate and oil coatings.

<sup>b</sup> "Dry" means plain or zinc plated without any lubrication.

**CAUTION:** Use only metric tools on metric hardware. Other tools may not fit properly. Tool may slip and cause injury.

DO NOT use these values if a different torque value or tightening procedure is given for a specific application. Torque values listed are for general use only. Check tightness of fasteners periodically.

Shear bolts are designed to fail under predetermined loads. Always replace shear bolts with identical property class.

Fasteners should be replaced with the same or higher property class. If higher property class fasteners are used, these should only be tightened to the strength of the original.

Make sure fastener threads are clean and that you properly start thread engagement. This will prevent them from failing when tightening.

Tighten plastic insert or crimped steel-type lock nuts to approximately 50 percent of the dry torque shown in the chart, applied to the nut, not to the bolt head. Tighten toothed or serrated-type lock nuts to the full torque value.

OUT3035,TORQUE2 -19-22MAR04-1/1

TORQ2—UN—15APR13

### Additional Metric Cap Screw Torque Values

**⚠ CAUTION:** Use only metric tools on metric hardware. Other tools may not fit properly. They may slip and cause injury.

Check tightness of cap screws periodically. Torque values listed are for general use only. Do not use these values if a different torque value or tightening procedure is listed for a specific application.

Shear bolts are designed to fail under predetermined loads. Always replace shear bolts with identical grade.

Fasteners should be replaced with the same or higher grade. If higher grade fasteners are used, these should only be tightened to the strength of the original.

Make sure fastener threads are clean and that the thread engagement is properly started. This will prevent fasteners from failing when tightening.

Tighten cap screws having lock nuts to approximately 50 percent of amount shown in chart.

METRIC CAP SCREW TORQUE VALUES <sup>a</sup>						
Nominal Diameter	T-Bolt		H-Bolt		M-Bolt	
	N-m	lb-ft	N-m	lb-ft	N-m	lb-ft
8	29	21	20	15	10	7
10	63	46	45	33	20	15
12	108	80	88	65	34	25
14	176	130	137	101	54	40
16	265	195	206	152	78	58
18	392	289	294	217	118	87
20	539	398	392	289	167	125
22	735	542	539	398	216	159
24	931	687	686	506	274	202
27	1372	1012	1029	759	392	289
30	1911	1410	1421	1049	539	398
33	2548	1890	1911	1410	735	542
36	3136	2314	2401	1772	931	687

<sup>a</sup>Torque tolerance is ±10%.



T6873AA

T-Bolt



T6873AB

H-Bolt



T6873AC

M-Bolt

T6873AA—UN—15APR13

T6873AB—UN—18OCT88

T6873AC—UN—18OCT88

## Unified Inch Bolt and Cap Screw Torque Values

UNIFIED INCH BOLT AND CAP SCREW TORQUE VALUES—Tolerance is ±10% unless otherwise specified

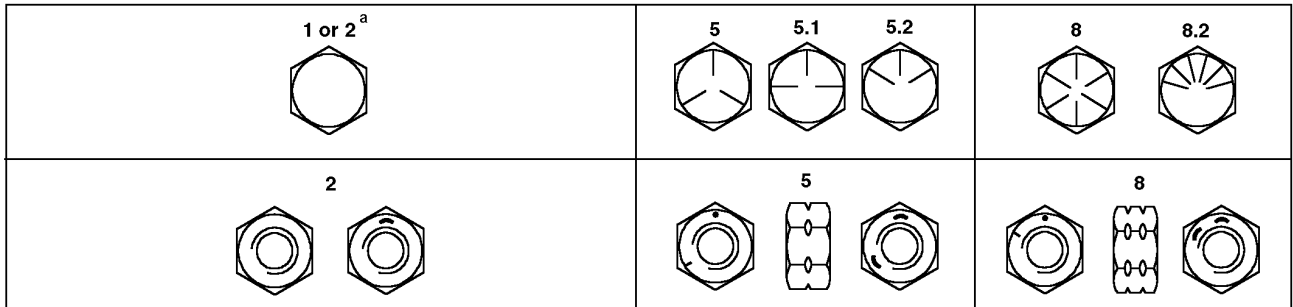

Top—SAE Grade and Head Markings; Bottom—SAE Grade and Nut Markings

Thread Size	Grade 1 (No Mark)		Grade 2 <sup>a</sup> (No Mark)		Grade 5, 5.1 or 5.2		Grade 8 or 8.2	
	Lubricated <sup>b</sup> N·m (lb-ft)	Dry <sup>c</sup> N·m (lb-ft)	Lubricated <sup>b</sup> N·m (lb-ft)	Dry <sup>c</sup> N·m (lb-ft)	Lubricated <sup>b</sup> N·m (lb-ft)	Dry <sup>c</sup> N·m (lb-ft)	Lubricated <sup>b</sup> N·m (lb-ft)	Dry <sup>c</sup> N·m (lb-ft)
1/4	3.8 (2.8)	4.7 (3.5)	6 (4.4)	7.5 (5.5)	9.5 (7)	12 (9)	13.5 (10)	17 (12.5)
5/16	7.7 (5.7)	9.8 (7.2)	12 (9)	15.5 (11.5)	19.5 (14.5)	25 (18.5)	28 (20.5)	35 (26)
3/8	13.5 (10)	17.5 (13)	22 (16)	27.5 (20)	35 (26)	44 (32.5)	49 (36)	63 (46)
7/16	22 (16)	28 (20.5)	35 (26)	44 (32.5)	56 (41)	70 (52)	80 (59)	100 (74)
1/2	34 (25)	42 (31)	53 (39)	67 (49)	85 (63)	110 (80)	120 (88)	155 (115)
9/16	48 (35.5)	60 (45)	76 (56)	95 (70)	125 (92)	155 (115)	175 (130)	220 (165)
5/8	67 (49)	85 (63)	105 (77)	135 (100)	170 (125)	215 (160)	240 (175)	305 (225)
3/4	120 (88)	150 (110)	190 (140)	240 (175)	300 (220)	380 (280)	425 (315)	540 (400)
7/8	190 (140)	240 (175)	190 (140)	240 (175)	490 (360)	615 (455)	690 (510)	870 (640)
1	285 (210)	360 (265)	285 (210)	360 (265)	730 (540)	920 (680)	1030 (760)	1300 (960)
1-1/8	400 (300)	510 (375)	400 (300)	510 (375)	910 (670)	1150 (850)	1450 (1075)	1850 (1350)
1-1/4	570 (420)	725 (535)	570 (420)	725 (535)	1280 (945)	1630 (1200)	2050 (1500)	2600 (1920)
1-3/8	750 (550)	950 (700)	750 (550)	950 (700)	1700 (1250)	2140 (1580)	2700 (2000)	3400 (2500)
1-1/2	990 (730)	1250 (930)	990 (730)	1250 (930)	2250 (1650)	2850 (2100)	3600 (2650)	4550 (3350)

<sup>a</sup> Grade 2 applies for hex cap screws (not hex bolts) up to 6 in. (152 mm) long. Grade 1 applies for hex cap screws over 6 in. (152 mm) long, and for all other types of bolts and screws of any length.

<sup>b</sup> "Lubricated" means coated with a lubricant such as engine oil, or fasteners with phosphate and oil coatings.

<sup>c</sup> "Dry" means plain or zinc plated without any lubrication.

DO NOT use these values if a different torque value or tightening procedure is given for a specific application. Torque values listed are for general use only. Check tightness of fasteners periodically.

Shear bolts are designed to fail under predetermined loads. Always replace shear bolts with identical grade.

Fasteners should be replaced with the same or higher grade. If higher grade fasteners are used, these should only be tightened to the strength of the original.

Make sure fastener threads are clean and that you properly start thread engagement. This will prevent them from failing when tightening.

Tighten plastic insert or crimped steel-type lock nuts to approximately 50 percent of the dry torque shown in the chart, applied to the nut, not to the bolt head. Tighten toothed or serrated-type lock nuts to the full torque value.

OUT3035,TORQUE1 -19-14JAN04-1/1

TORQ1A—UN—15APR13

## Check Oil Lines and Fittings

**⚠ CAUTION:** Escaping fluid under pressure can penetrate the skin causing serious injury. Avoid the hazard by relieving pressure before disconnecting hydraulic or other lines. Tighten all connections before applying pressure. Search for leaks with a piece of cardboard. Protect hands and body from high pressure fluids.

If an accident occurs, see a doctor immediately. Any fluid injected into the skin must be surgically removed within a few hours or gangrene may result. Doctors unfamiliar with this type of injury may call the Deere & Company Medical Department in Moline, Illinois, or other knowledgeable medical source.

Check all oil lines, hoses and fittings regularly for leaks or damage. Make sure all clamps are in position and tight. Make sure hoses are not twisted or touching machine parts which are moving.

Tubing with dents may cause the oil to overheat. If you find tubing with dents, install new tubing immediately.

**IMPORTANT:** Tighten fittings as specified in torque chart.

When you tighten connections, use two wrenches to prevent bending or breaking tubing and fittings.

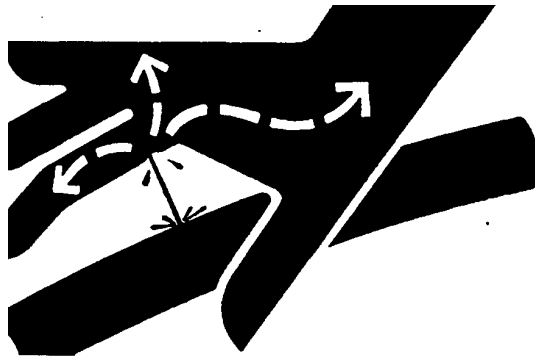

X9811 —UN—23AUG88

T85401 —UN—24JAN89

T82,FLMA,AI -19-14MAR90-1/1

## Service Recommendations for O-Ring Boss Fittings

### Straight Fitting

1. Inspect O-ring boss seat for dirt or defects.
2. Lubricate O-ring with petroleum jelly. Place electrical tape over threads to protect O-ring. Slide O-ring over tape and into O-ring groove of fitting. Remove tape.
3. Tighten fitting to torque value shown on chart.

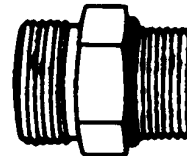

Straight Fitting

Continued on next page

04T,90,K66 -19-29SEP99-1/2

T6243AE —UN—15APR13



Please click here and go  
back to our website.

**BUY NOW**

Then Instant Download the  
Complete Manual.

Thank you very much!