

JD844 Loader

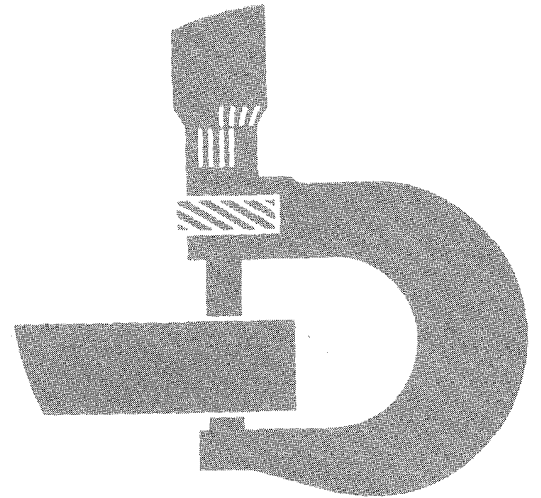

TECHNICAL MANUAL

**John Deere Dubuque Works
TM-1189 (May-86)**

Litho in U.S.A.

JD844 LOADER
Technical Manual
TM-1189 (May-86)

SECTION AND GROUP CONTENTS OF THIS MANUAL

SECTION I - GENERAL INFORMATION

- Group I - Contents, Index and Page List
- Group II - Introduction and Safety Information
- Group III - General Specifications
- Group IV - Predelivery, Delivery, and After-Sale Services
- Group V - Lubrication

SECTION 1 - WHEELS

- Group 0110 - Powered Wheels and Fastenings
- Group 0199 - Specifications and Special Tools

SECTION 2 - AXLES AND SUSPENSION SYSTEMS

- Group 0201 - Drive Axle Housing and Support
- Group 0210 - Differential or Bevel Drive
- Group 0225 - Input Drive Shafts and U-Joints
- Group 0250 - Axle Shaft, Bearings, Reduction Gears
- Group 0299 - Specifications and Special Tools

SECTION 3 - TRANSMISSION

- Group 0315 - Controls
- Group 0325 - Input Drive Shafts and U-Joints
- Group 0341 - Housings and Covers
- Group 0342 - Mounting Parts
- Group 0350 - Gears, Shafts, Bearings, and Power Shift Clutch
- Group 0360 - Hydraulic System
- Group 0399 - Specifications and Special Tools

SECTION 4 - ENGINE

- Group 0400 - Removal and Installation
- Group 0401 - Crankshaft and Main Bearings
- Group 0402 - Camshaft and Valve Actuating Means
- Group 0403 - Connecting Rods and Pistons
- Group 0404 - Cylinder Block
- Group 0407 - Oiling System
- Group 0408 - Ventilating System
- Group 0409 - Cylinder Head and Valves
- Group 0410 - Exhaust Manifold
- Group 0413 - Fuel Injection System
- Group 0414 - Intake Manifold
- Group 0416 - Turbocharger
- Group 0417 - Water Pump
- Group 0418 - Thermostats, Housings, and Water Piping
- Group 0419 - Oil Cooler
- Group 0422 - Starting Motor and Fastenings
- Group 0429 - Fan Drive
- Group 0433 - Flywheel, Housing and Fastenings

SECTION 5 - ENGINE AUXILIARY SYSTEMS

- Group 0505 - Cold Weather Starting Aids
- Group 0510 - Cooling Systems
- Group 0515 - Speed Controls
- Group 0520 - Intake System
- Group 0530 - External Exhaust System
- Group 0540 - Mounting Frame
- Group 0560 - External Fuel Supply Systems
- Group 0599 - Specifications and Special Tools

SECTION 6 - TORQUE CONVERTER

- Group 0641 - Housing and Cover
- Group 0651 - Turbine, Gears, Shaft, etc.
- Group 0699 - Specifications and Special Tools

SECTION AND GROUP CONTENTS OF THIS MANUAL—Continued

SECTION 9 - STEERING SYSTEM

- Group 0930 - Emergency Steering
- Group 0960 - Hydraulic System
- Group 0999 - Specifications and Special Tools

SECTION 10 - SERVICE BRAKES

- Group 1011 - Active Elements
- Group 1015 - Controls Linkage
- Group 1060 - Hydraulic System
- Group 1099 - Specifications and Special Tools

SECTION 15 - EQUIPMENT ATTACHING

- Group 1511 - Drawbar

SECTION 16 - ELECTRICAL SYSTEMS

- Group 1671 - Batteries, Support and Cables
- Group 1672 - Alternator, Regulator and Charging System Wiring
- Group 1673 - Lighting System
- Group 1674 - Wiring Harness and Switches
- Group 1675 - System Controls
- Group 1676 - Instruments and Indicators
- Group 1699 - Specifications and Special Tools

SECTION 17 - FRAME, CHASSIS OR SUPPORTING STRUCTURE

- Group 1740 - Frame Installation
- Group 1746 - Frame Bottom Guards
- Group 1749 - Chassis Weights
- Group 1799 - Specifications and Special Tools

SECTION 18 - OPERATOR'S STATION

- Group 1810 - Operator Enclosure
- Group 1830 - Heating and Air Conditioning
- Group 1899 - Specifications and Special Tools

SECTION 19 - SHEET METAL AND STYLING

- Group 1910 - Hood or Engine Enclosure
- Group 1921 - Grille and Grille Housing
- Group 1927 - Fenders

SECTION 20 - SAFETY, CONVENIENCE AND MISCELLANEOUS

- Group 2002 - Mirrors
- Group 2003 - Fire Extinguishers
- Group 2004 - Horn and Warning Devices
- Group 2006 - Cigar Lighter

SECTION 31 - LOADER

- Group 3102 - Buckets
- Group 3115 - Controls Linkage
- Group 3140 - Frames
- Group 3160 - Hydraulic System
- Group 3199 - Specifications and Special Tools

SECTION 90 - SYSTEM TESTING

- Group 9005 - General Information
- Group 9010 - Engine
- Group 9015 - Electrical System
- Group 9020 - Power Train
- Group 9025 - Hydraulic System (Flow Meter)
- Group 9030 - Miscellaneous Components
- Group 9031 - Heating and Air Conditioning
- Group 9035 - Specifications and Special Tools

The specifications and design information contained in this

MAINTENANCE WITHOUT ACCIDENT WORK SAFELY



T27999N

 This safety alert symbol is used for important safety messages. When you see this symbol, the possibility of personal injury exists if safety message is not followed.

**EVERY EMPLOYER HAS A
SAFETY PROGRAM. KNOW
WHAT IT IS!**

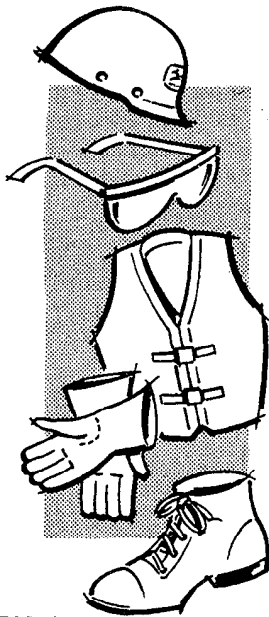

T27501N

Consult your shop supervisor for specific instructions on a job, and the safety equipment required.

For instance, you may need: Hard hat, safety shoes, safety goggles, heavy gloves, reflector vests, ear protectors, respirators.

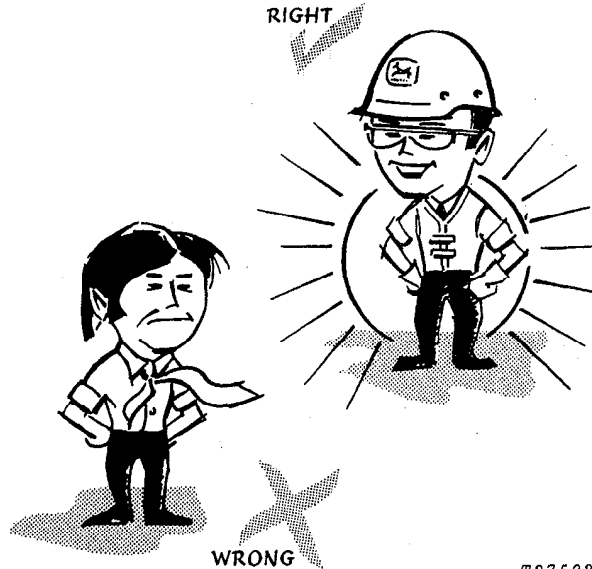

T27502N

ALWAYS AVOID loose clothing or any accessories—flopping cuffs, dangling neckties and scarves, or rings and wrist watches—that can catch in moving parts and put you out of work.

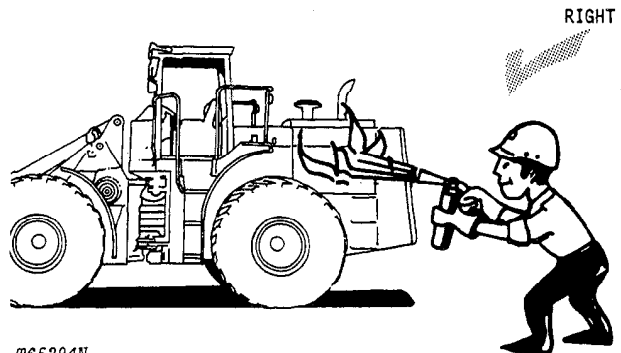

T65294N

BE ALERT!

Plan ahead—work safely—avoid accidental damage and injury. If a careless moment does cause an accident or fire, react quickly with the tools and skills at hand—know how to use a first aid kit and a fire extinguisher—and where to get aid and assistance. In an emergency, split-second action is the key to safety.

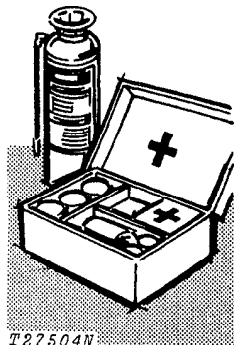

T27504N

MAINTENANCE WITHOUT ACCIDENT

Specific safety procedures should always be observed, whether servicing or making repairs on the loader. Remember these—in time!—can prevent an injury... or save your life....

AVOID FIRE HAZARDS—

Fuel Is Dangerous!

Don't smoke while refueling.

Don't smoke while handling highly flammable material.

Engine should be shut off when refueling.
Use care in refueling if the engine is hot.

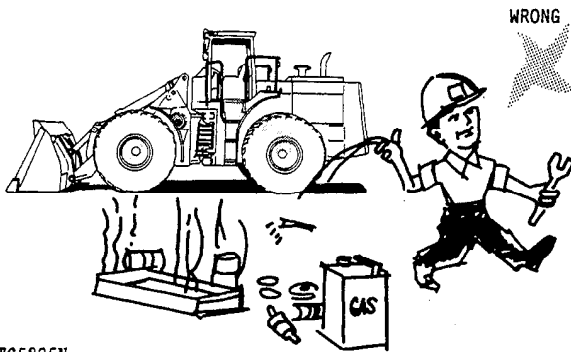

Don't use open pans of gasoline or diesel fuel for cleaning parts. Good commercial, nonflammable solvents are preferred.

Battery Gas Is Highly Flammable!

Provide adequate ventilation when charging batteries.



Don't check battery charge by placing metal objects across the posts.

Don't allow sparks or open flame near batteries.
Don't smoke near battery.

Flame Is Not a Flashlight!

Never check fuel, battery electrolyte or coolant levels with an open flame.

Never use an open flame to look for leaks anywhere on the equipment.

Never use an open flame as a light anywhere on or around the equipment.

KNOW WHERE FIRE EXTINGUISHERS ARE KEPT!

UNDER ALL MAINTENANCE CONDITIONS—

Do not perform any work on the loader unless authorized to do so. Then be sure you understand the services required. Follow recommended procedures.

Never service the equipment while it is being operated.

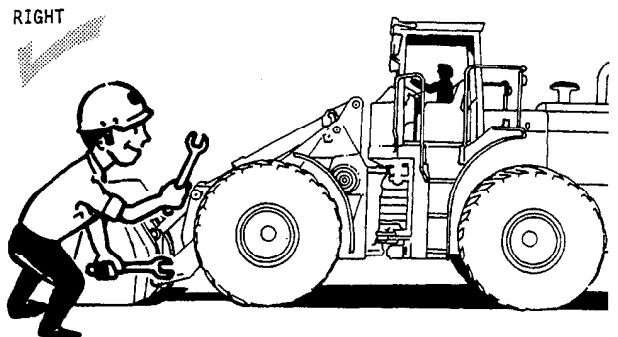

Avoid working on equipment with the engine running. If it is necessary to make checks with the engine running, **ALWAYS USE TWO SERVICE TECHNICIANS**—one, the operator, at the controls, the other checking in view of the operator. Also, put the transmission in neutral, set the brake, and apply any safety locks provided. **KEEP HANDS AWAY FROM MOVING PARTS.**

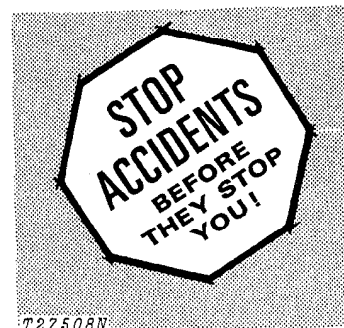

MAINTENANCE WITHOUT ACCIDENT

Before servicing, adjusting, or repairing loaders which have attachments—**LOWER** attachments to the ground—or, if necessary to raise them for access to certain parts, **SECURELY SUPPORT** by external means. **DO NOT** rely on controls to support or position attachments for maintenance.

Never allow **ANYONE** to walk under equipment that is raised and not properly blocked.

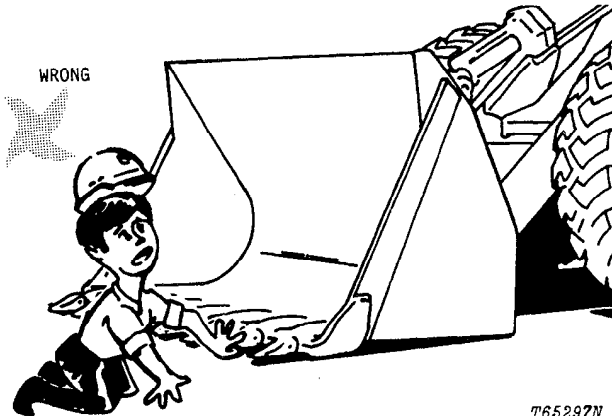

T65297N

Avoid working directly under raised and blocked equipment unless absolutely necessary.

If the loader is on an incline, block it securely.

Use hoisting equipment for lifting heavy parts. **TAKE CARE! WATCH OUT FOR OTHER PEOPLE IN THE VICINITY.**

Use extreme caution in removing radiator caps, drain plugs, grease fittings, or hydraulic pressure caps.

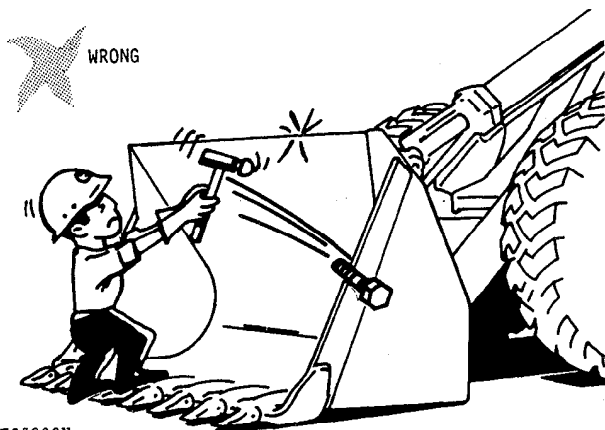

T65298N

Wear safety glasses when drilling, grinding, or hammering metal.

Make sure the maintenance area is adequately vented.

Keep maintenance area **CLEAN AND DRY**. Oily and wet floors are slippery; greasy rags are a fire hazard; wet spots are dangerous when working with electrical equipment.

Store starting aids in a cool and well-ventilated place, out of the reach of unauthorized personnel.

SERVICING PRECAUTIONS

Stop the engine before cleaning or lubricating the loader.

Lower mounted equipment and tools to the ground *carefully*.



T65299N

Engine coolant gets hot! Don't remove the radiator cap until coolant temperature is below the boiling point. Then turn cap slightly to relieve pressure before removing.

Exhaust gases are dangerous! Periodically check exhaust system for excessive leakage.

Don't forget a hydraulic system may be pressurized! To relieve system pressure, stop engine, lower bucket and operate loader control lever and steering wheel and brake pedals until system fails to respond.

When checking hydraulic pressure, be sure to use the correct test gauge for the pressure in the particular system.

The loader is equipped with brake and differential lock accumulators—recharge by using only dry nitrogen. To discharge brake accumulator apply the brake pedal about 30 times. To discharge differential lock accumulator depress differential lock switch.

Group III GENERAL SPECIFICATIONS

(Specifications and design are subject to change without notice. Wherever applicable, specifications are in accordance with ICED and SAE Standards. Except where otherwise noted, specifications are based on a machine equipped with all standard equipment, 26.5-25, 20-PR, L-3 tires with 3230 lb [1465 kg] of CaCl₂ solution in rear tires, ROPS cab, rear counterweight, full fuel tank, and 175 lb [79.4 kg] operator.)

Power (at 2100 engine rpm):	SAE	DIN
Gross	290 hp (216 kW*)	
Net	260 hp (194 kW)	264 PS

*Net engine flywheel horsepower is for an engine equipped with fan, air cleaner, water pump, lubricating oil pump, fuel pump, alternator, and muffler. The gross engine power is without fan. Flywheel power ratings are under SAE standard conditions of 500-ft. (150 m) altitude and 85°F (29°C) temperature and DIN 70 020 conditions (non-corrected). No derating is required up to 10,000 feet (3000 m) altitude.

**In the International System of Units (SI), power is expressed in kilowatts (kW).

Engine:	John Deere turbocharged diesel, V-8, valve-in-head, 4-stroke cycle.
Bore and stroke	5.5 x 5 in. (140 x 127 mm)
Piston displacement	955 cu. in. (15.652 L)
Compression ratio	15.5 to 1
Maximum torque @ 1,400 rpm	858 lb-ft (1163 Nm) (118.6 kg-m)
NACC or AMA (U.S. Tax) horsepower	96.8
Lubrication	Pressure system with full-flow filters
Cooling ..	Pressurized with thermostat and controlled by-pass
Fan	Blower
Air cleaner with restriction indicator	Dry
Electrical system	24-volt (24 v) with alternator
Batteries (4)	Reserve capacity: 170 minutes each

Torque Converter:		
Type	Single stage	
Torque multiplication	2.84 to 1	
Transmission	Power shift planetary	

Forward Speeds	mph	km/h
1	0-4.5	0-7.2
2	0-7.9	0-12.7
3	0-13.3	0-21.4
4	0-23.4	0-37.7

Reverse Speeds		
1	0-4.9	0-7.9
2	0-8.8	0-14.2
3	0-14.7	0-23.7

Differentials:	
Front	Conventional or hydraulic lock
Rear	Conventional

Drive Axles... Inboard-mounted planetary gears to each wheel. Front axle fixed. Rear axle oscillates 22-degrees total, 17.2 inches (436 mm) vertical travel at center of tire.

Brakes:
 Service... Power actuated, 4-wheel, inboard-mounted wet disk. Separate front and rear hydraulic circuits. Foot-operated by either right or left pedal. Selective transmission disconnect with left pedal operation. Emergency braking accumulators.

Parking... Hand-operated park lock on transmission output shaft.

Steering... Full power steering. Automatically actuated emergency steering. Frame articulated 74 degrees by two hydraulic cylinders. Turning radius of 19 ft. 5 in. (5.92 m).

Hydraulic Systems:
 Loader and steering functions... Three engine driven vane pumps. Main loader pump delivers 68 gpm (4.3 L/s) at 2250 psi (15 514 kPa) (158.2 kg/cm²) and 2100 engine rpm. Main steering pump delivers 42 gpm (2.65 L/s) at 2250 psi (15 514 kPa) (158.2 kg/cm²) and 2100 engine rpm. Swing pump delivers 26.5 gpm (1.67 L/s) at 2250 psi (15 514 kPa) (158.2 kg/cm²) and 2100 engine rpm.

Brakes... Engine-driven gear pump delivers 3.9 gpm (0.25 L/s) at 2100 psi (14 480 kPa) (147.6 kg/cm²) and 2100 engine rpm.

Hydraulic Cylinders: Bore Stroke
| Boom, two . . . 7.50 in. (190 mm) 33.58 in. (853 mm)
Bucket, one . . . 7.50 in. (190 mm) 38.86 in. (987 mm)
Cylinder rods Ground, heat-treated,
chrome-plated, polished
Boom and bucket cylinder
rods 3.75 in. (97 mm) dia.

Tires:
26.5-25, 20-ply-rating, L-3
26.5-25, 20-ply-rating, L-4
26.5-25, 20-ply-rating, L-5

Wheel Treads:
Front and rear 90 in. (2.29 m)

Capacities:	U.S.	Liters
Cooling system	20 gal.	75.7 L
Fuel tank	100 gal.	378.5 L
Crankcase with filter	38 qt.	36 L
Transmission case and filters	55 qt.	52 L
Front differential	33 qt.	31.3 L
Rear differential	33 qt.	31.3 L
Loader hydraulic sump	50 gal.	189.3 L

Additional Standard Equipment:
Deluxe suspension seat
Engine side shields

Gauges:
Transmission oil temperature
Transmission oil pressure
Fuel
Coolant temperature
Engine oil pressure
Electric hour meter
Voltmeter

Loader hydraulic system level indicator
Key switch
Pushbutton safety start
Starting aid
Cigar lighter
Transistorized voltage regulator
Vandal protection
Horn
ROPS cab with 3-in. (76 mm) seat belt, heater, de-
froster, pressurizer, front and rear windshield wipers
and washers, rear-view mirrors, front and rear work
lights, and floor mat
Fuel filters
Automatic return-to-dig
Fixed drawbar
Rear bottom guard
Hand grips
Access ladders, both sides
Antifreeze
Reverse warning alarm

Special Equipment:
ROPS canopy with seat belt, rear-view mirrors and
work lights
Instrument panel cover with lock
Triple-spool hydraulic valve
Bucket teeth
License plate bracket
Auxiliary cutting edges
Auxiliary bucket spill guard
Air conditioning
Fire extinguisher
Adjustable boom height control
Front locking differential
Rear weight

LOADER DIMENSIONS

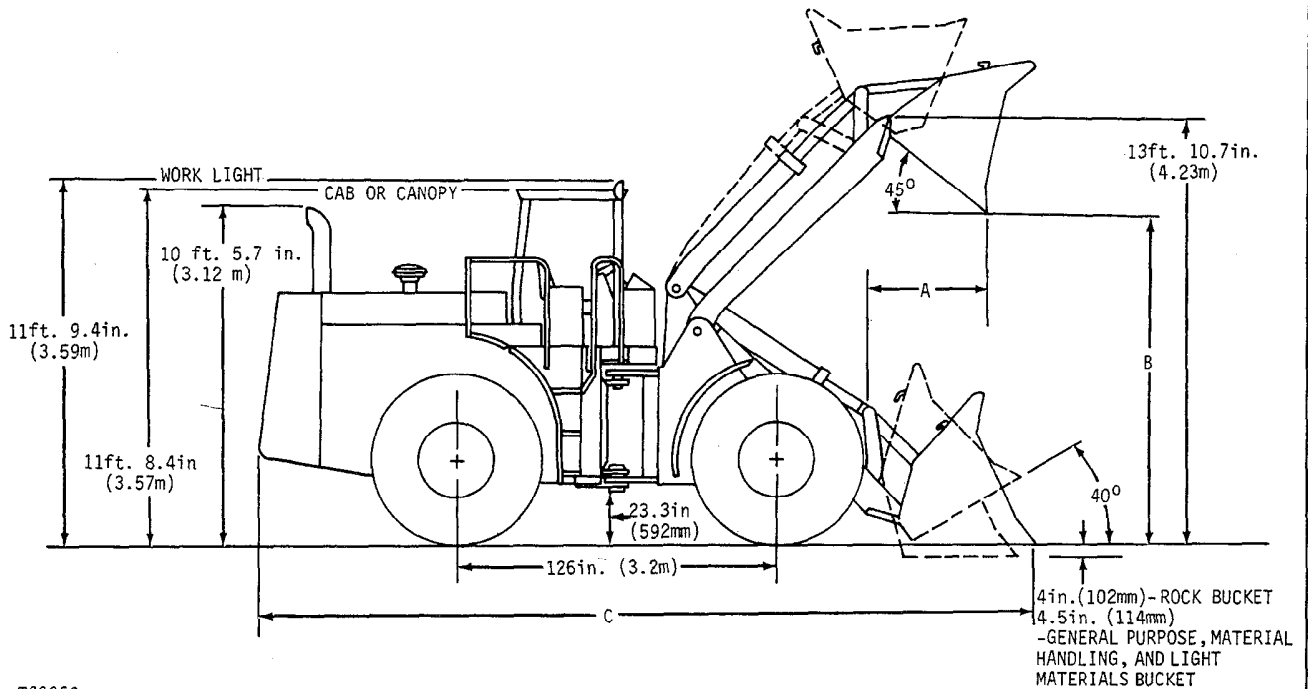

If 26.5-25, L4 or L5 tires are used, add 2 inches (50 mm) to all vertical dimensions except digging depth. Digging depth will be 2 inches (50 mm) less.

BUCKET CAPACITIES	DIMENSIONS		
	A	B	C
4-1/2 cu. yd. general purpose bucket (3.44 m ³)	41.5 in. (1.05 m)	10 ft. 5.9 in. (3.20 m)	26 ft. 1.4 in. (7.96 m)
5 cu. yd. general purpose bucket (3.82 m ³)	43.5 in. (1.10 m)	10 ft. 4 in. (3.15 m)	26 ft. 4.1 in. (8.03 m)
5-1/2 cu. yd. materials handling bucket (4.20 m ³)	45 in. (1.14 m)	10 ft. 2.4 in. (3.11 m)	26 ft. 6.4 in. (8.09 m)
7 cu. yd. light materials bucket (5.35 m ³)	50 in. (1.27 m)	9 ft. 9.3 in. (2.98 m)	27 ft. 1.5 in. (8.27 m)
4-1/2 cu. yd. spade-nose rock bucket (3.44 m ³)	48.9 in. (1.24 m)	9 ft. 11.1 in. (3.03 m)	26 ft. 11 in. (8.20 m)

LOADER OPERATING INFORMATION

OPERATING INFORMATION	BUCKET				
	General Purpose	General Purpose	Materials Handling	Light Materials	Spade Nose Rock
Capacity, heaped, SAE	4.5 cu. yd. (3.44 m ³)	5.0 cu. yd. (3.82 m ³)	5.5 cu. yd. (4.20 m ³)	7.0 cu. yd. (5.35 m ³)	4.5 cu. yd. (3.44 m ³)
Capacity, struck, SAE	3.65 cu. yd. (2.79 m ³)	4.12 cu. yd. (3.15 m ³)	4.56 cu. yd. (3.49 m ³)	5.75 cu. yd. (4.40 m ³)	3.65 cu. yd. (2.79 m ³)
Bucket width	128 in. (3.25 m)	128 in. (3.25 m)	128 in. (3.25 m)	135 in. (3.43 m)	128 in. (3.25 m)
Bucket weight	3910 lb. (1780 kg)	4190 lb. (1900 kg)	4320 lb. (1960 kg)	4520 lb. (2050 kg)	5280 lb. (2400 kg)
Breakout force, J732C SAE Standard	35,070 lb. (156.0 kN) (15 910 kg)	33,070 lb. (147.1 kN) (15 000 kg)	32,530 lb. (144.7 kN) (14 760 kg)	30,160 lb. (134.2 kN) (13 680 kg)	30,620 lb. (136.2 kN) (13 890 kg)
Tipping load, straight	38,450 lb. (17 440 kg)	38,040 lb. (17 260 kg)	37,780 lb. (17 140 kg)	37,170 lb. (16 860 kg)	37,180 lb. (16 870 kg)
Tipping load, Full turn, SAE	34,440 lb. (15 620 kg)	34,030 lb. (15 440 kg)	33,790 lb. (15 330 kg)	33,210 lb. (15 060 kg)	33,170 lb. (15 040 kg)
Turning clearance circle	45 ft. 7.5 in. (13.91 m)	45 ft. 9 in. (13.94 m)	45 ft. 10.3 in. (13.98 m)	46 ft. 8.9 in. (14.25 m)	45 ft. 6.5 in. (13.88 m)
Loader operating weight	51,620 lb. (23 410 kg)	51,900 lb. (23 540 kg)	52,030 lb. (23 600 kg)	52,230 lb. (23 690 kg)	52,990 lb. (24 040 kg)

ADJUSTMENTS TO OPERATING WEIGHTS AND TIPPING LOADS:

Add (+) or deduct (-) lb. (kg) as indicated for loader equipped with:	Loader Operating Weight	Tipping Load, Straight	Tipping Load, Full Turn, SAE
Less ROPS cab	-900 lb. (410 kg)	-800 lb. (360 kg)	-760 lb. (350 kg)
ROPS canopy in lieu of ROPS cab	-400 lb. (180 kg)	-360 lb. (160 kg)	-340 lb. (150 kg)
Less rear counterweight	-900 lb. (410 kg)	-1930 lb. (880 kg)	-1670 lb. (760 kg)
Remove fluid	-3230 lb. (1460 kg)	-4440 lb. (2010 kg)	-3990 lb. (1810 kg)
Change to 26.5 L4 tires	+1400 lb. (640 kg)	+960 lb. (440 kg)	+870 lb. (400 kg)
Change to 26.5 L5 tires	+2260 lb. (1030 kg)	+1550 lb. (700 kg)	+1400 lb. (640 kg)