

JOHN DEERE
WORLDWIDE COMMERCIAL & CONSUMER
EQUIPMENT DIVISION

Garden Tractors
X465, X475, X485, X575 and X585

TM2023 JUNE 2004

TECHNICAL MANUAL



JOHN DEERE

North American Version
Litho in U.S.A.

INTRODUCTION

Manual Description

This technical manual is written for an experienced technician and contains sections that are specifically for this product. It is a part of a total product support program.

The manual is organized so that all the information on a particular system is kept together. The order of grouping is as follows:

- Table of Contents
- Specifications and Information
- Identification Numbers
- Tools and Materials
- Component Location
- Schematics and Harnesses
- Theory of Operation
- Operation and Diagnostics
- Diagnostics
- Tests and Adjustments
- Repair
- Other

NOTE: Depending on the particular section or system being covered, not all of the above groups may be used.

The bleed tabs for the pages of each section will align with the sections listed on this page. Page numbering is consecutive from the beginning of the Safety section through the last section.

We appreciate your input on this manual. If you find any errors or want to comment on the layout of the manual please contact us.

Safety

Specifications and Information

Engine - Gas (Air-Cooled)

Engine - Gas (Liquid-Cooled)

Electrical

Power Train - Hydrostatic

Hydraulics

Steering

Brakes

Attachments

Miscellaneous

All information, illustrations and specifications in this manual are based on the latest information at the time of publication. The right is reserved to make changes at any time without notice.

COPYRIGHT© 2004
Deere & Co.
John Deere Worldwide Commercial and
Consumer Equipment Division
All rights reserved
Previous Editions
COPYRIGHT© 2002; 2003

SAFETY

Recognize Safety Information



MIF

This is the safety-alert symbol. When you see this symbol on your machine or in this manual, be alert to the potential for personal injury.

Follow recommended precautions and safe servicing practices.

Understand Signal Words

A signal word - DANGER, WARNING, or CAUTION - is used with the safety-alert symbol. DANGER identifies the most serious hazards.

DANGER or WARNING safety signs are located near specific hazards. General precautions are listed on CAUTION safety signs. CAUTION also calls attention to safety messages in this manual.

Replace Safety Signs

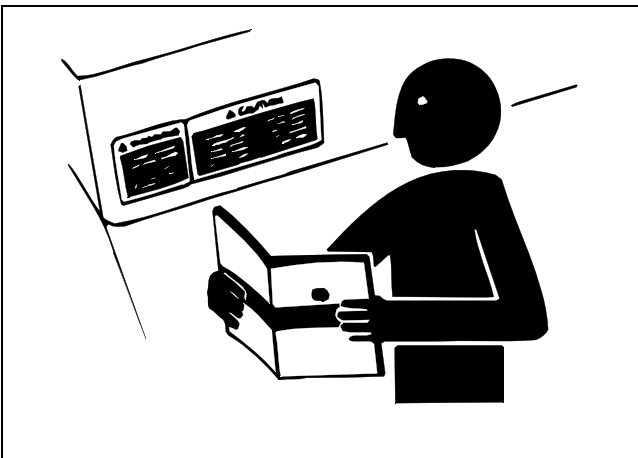

MIF

Replace missing or damaged safety signs. See the machine operator's manual for correct safety sign placement.

Handle Fluids Safely - Avoid Fires

Be Prepared For Emergencies

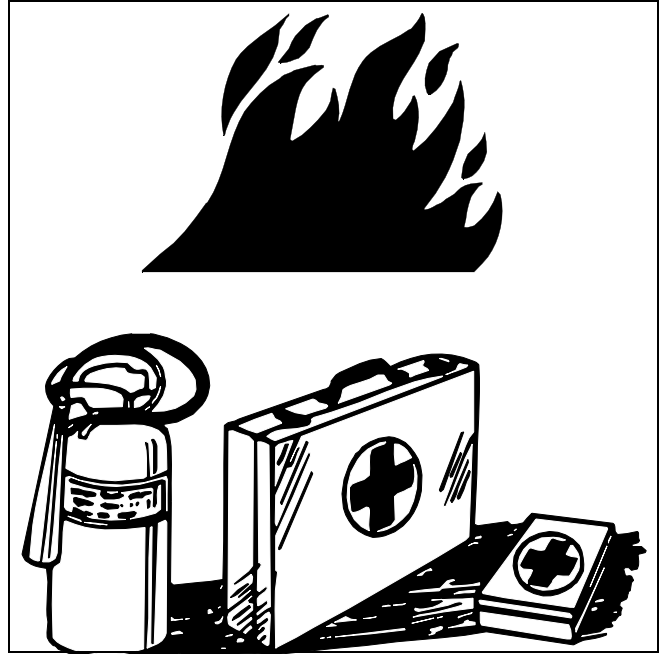

MIF

- When you work around fuel, do not smoke or work near heaters or other fire hazards.
- Store flammable fluids away from fire hazards. Do not incinerate or puncture pressurized containers.
- Make sure machine is clean of trash, grease, and debris.
- Do not store oily rags; they can ignite and burn spontaneously.
- Be prepared if a fire starts.
- Keep a first aid kit and fire extinguisher handy.
- Keep emergency numbers for doctors, ambulance service, hospital, and fire department near your telephone.

Use Care In Handling And Servicing Batteries

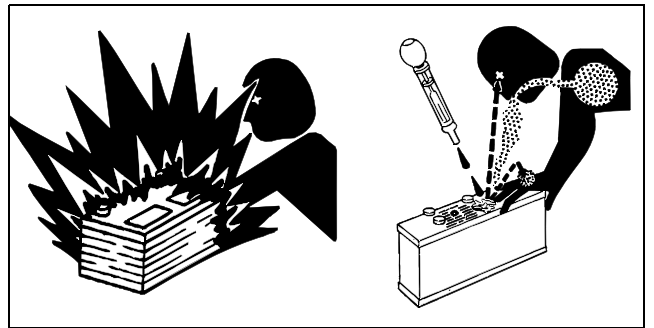

MIF

SAFETY

Prevent Battery Explosions

- Keep sparks, lighted matches, and open flame away from the top of battery. Battery gas can explode.
- Never check battery charge by placing a metal object across the posts. Use a volt-meter or hydrometer.
- Do not charge a frozen battery; it may explode. Warm battery to 16°C (60°F).

Prevent Acid Burns

- Sulfuric acid in battery electrolyte is poisonous. It is strong enough to burn skin, eat holes in clothing, and cause blindness if splashed into eyes.

Avoid acid burns by:

1. Filling batteries in a well-ventilated area.
2. Wearing eye protection and rubber gloves.
3. Avoiding breathing fumes when electrolyte is added.
4. Avoiding spilling or dripping electrolyte.
5. Use proper jump start procedure.

If you spill acid on yourself:

1. Flush your skin with water.
2. Apply baking soda or lime to help neutralize the acid.
3. Flush your eyes with water for 10 - 15 minutes.
4. Get medical attention immediately.

If acid is swallowed:

1. Drink large amounts of water or milk.
2. Then drink milk of magnesia, beaten eggs, or vegetable oil.
3. Get medical attention immediately.

Wear Protective Clothing

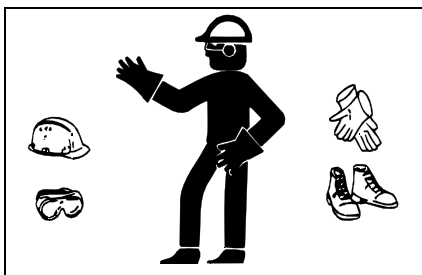

MIF

Wear close fitting clothing and safety equipment appropriate to the job.

Prolonged exposure to loud noise can cause impairment or loss of hearing. Wear a suitable hearing protective device

such as earmuffs or earplugs to protect against objectionable or uncomfortable loud noises.

Operating equipment safely requires the full attention of the operator. Do not wear radio or music headphones while operating machine.

Use Care Around High-pressure Fluid Lines

Avoid High-Pressure Fluids



MIF

Escaping fluid under pressure can penetrate the skin causing serious injury.

Avoid injury from escaping fluid under pressure by stopping the engine and relieving pressure in the system before disconnecting or connecting hydraulic or other lines. Tighten all connections before applying pressure.

Search for leaks with a piece of cardboard. Protect hands and body from high pressure fluids.

If an accident occurs, see a doctor immediately. Any fluid injected into the skin must be surgically removed within a few hours or gangrene may result. Doctors unfamiliar with this type of injury should reference a knowledgeable medical source. Such information is available from Deere & Company Medical Department in Moline, Illinois, U.S.A.

Avoid Heating Near Pressurized Fluid Lines



MIF

Flammable spray can be generated by heating near pressurized fluid lines, resulting in severe burns to yourself and bystanders. Do not heat by welding, soldering, or using a torch near pressurized fluid lines or other flammable materials. Pressurized lines can be accidentally cut when heat goes beyond the immediate flame area.

SAFETY

Service Machines Safely

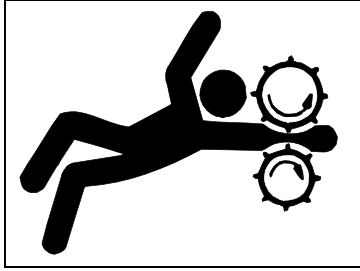

MIF

Tie long hair behind your head. Do not wear a necktie, scarf, loose clothing, or necklace when you work near machine tools or moving parts. If these items were to get caught, severe injury could result.

Remove rings and other jewelry to prevent electrical shorts and entanglement in moving parts.

Use Proper Tools

Use tools appropriate to the work. Makeshift tools and procedures can create safety hazards. Use power tools only to loosen threaded parts and fasteners. For loosening and tightening hardware, use the correct size tools. **DO NOT** use U.S. measurement tools on metric fasteners. Avoid bodily injury caused by slipping wrenches. Use only service parts meeting John Deere specifications.

Park Machine Safely

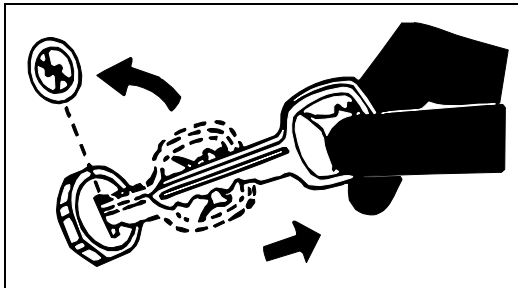

MIF

Before working on the machine:

1. Lower all equipment to the ground.
2. Stop the engine and remove the key.
3. Disconnect the battery ground strap.
4. Hang a "DO NOT OPERATE" tag in operator station.

Support Machine Properly and Use Proper Lifting Equipment

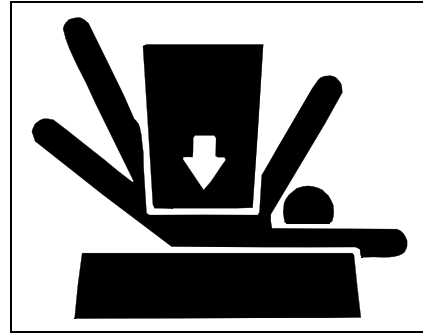

MIF

If you must work on a lifted machine or attachment, securely support the machine or attachment.

Do not support the machine on cinder blocks, hollow tiles, or props that may crumble under continuous load. Do not work under a machine that is supported solely by a jack. Follow recommended procedures in this manual.

Lifting heavy components incorrectly can cause severe injury or machine damage. Follow recommended procedure for removal and installation of components in the manual.

Work In Clean Area

Before starting a job:

1. Clean work area and machine.
2. Make sure you have all necessary tools to do your job.
3. Have the right parts on hand.
4. Read all instructions thoroughly; do not attempt shortcuts.

Using High Pressure Washers

Directing pressurized water at electronic/electrical components or connectors, bearings, hydraulic seals, fuel injection pumps or other sensitive parts and components may cause product malfunctions. Reduce pressure and spray at a 45 to 90 degree angle.

Illuminate Work Area Safely

Illuminate your work area adequately but safely. Use a portable safety light for working inside or under the machine. Make sure the bulb is enclosed by a wire cage. The hot filament of an accidentally broken bulb can ignite spilled fuel or oil.

SAFETY

Work In Ventilated Area

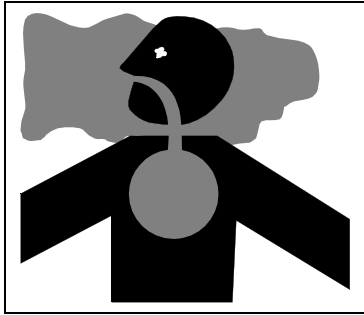

MIF

Engine exhaust fumes can cause sickness or death. If it is necessary to run an engine in an enclosed area, remove the exhaust fumes from the area with an exhaust pipe extension.

If you do not have an exhaust pipe extension, open the doors and get outside air into the area.

Warning: California Proposition 65 Warning

Gasoline engine exhaust from this product contains chemicals known to the State of California to cause cancer, birth defects, or other reproductive harm.

Diesel engine exhaust and some of its constituents are known to the State of California to cause cancer, birth defects, and other reproductive harm.

Remove Paint Before Welding or Heating

Avoid potentially toxic fumes and dust. Hazardous fumes can be generated when paint is heated by welding, soldering, or using a torch. Do all work outside or in a well ventilated area. Dispose of paint and solvent properly. Remove paint before welding or heating: If you sand or grind paint, avoid breathing the dust. Wear an approved respirator. If you use solvent or paint stripper, remove stripper with soap and water before welding. Remove solvent or paint stripper containers and other flammable material from area. Allow fumes to disperse at least 15 minutes before welding or heating.

Avoid Harmful Asbestos Dust

Avoid breathing dust that may be generated when handling components containing asbestos fibers. Inhaled asbestos fibers may cause lung cancer.

Components in products that may contain asbestos fibers are brake pads, brake band and lining assemblies, clutch plates, and some gaskets. The asbestos used in these components is usually found in a resin or sealed in some way. Normal handling is not hazardous as long as airborne dust containing asbestos is not generated.

Avoid creating dust. Never use compressed air for cleaning. Avoid brushing or grinding material containing asbestos. When servicing, wear an approved respirator. A special vacuum cleaner is recommended to clean asbestos. If not available, apply a mist of oil or water on the material containing asbestos. Keep bystanders away from the area.

Service Tires Safely

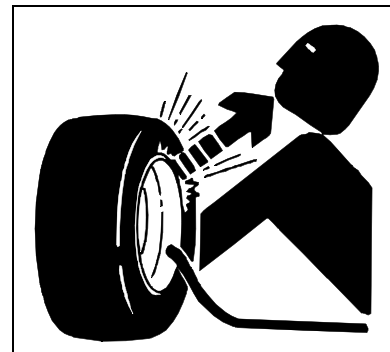

MIF

Explosive separation of a tire and rim parts can cause serious injury or death.

Do not attempt to mount a tire unless you have the proper equipment and experience to perform the job.

Always maintain the correct tire pressure. Do not inflate the tires above the recommended pressure. Never weld or heat a wheel and tire assembly. The heat can cause an increase in air pressure resulting in a tire explosion. Welding can structurally weaken or deform the wheel.

When inflating tires, use a clip-on chuck and extension hose long enough to allow you to stand to one side and NOT in front of or over the tire assembly. Use a safety cage if available.

Check wheels for low pressure, cuts, bubbles, damaged rims or missing lug bolts and nuts.

SAFETY

Avoid Injury From Rotating Blades, Augers And PTO Shafts

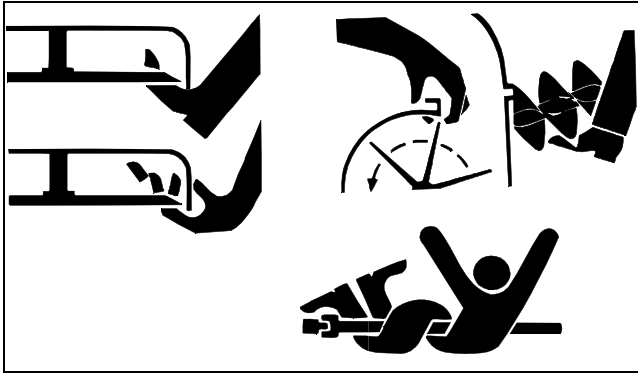

MIF

Keep hands and feet away while machine is running. Shut off power to service, lubricate or remove mower blades, augers or PTO shafts.

Service Cooling System Safely

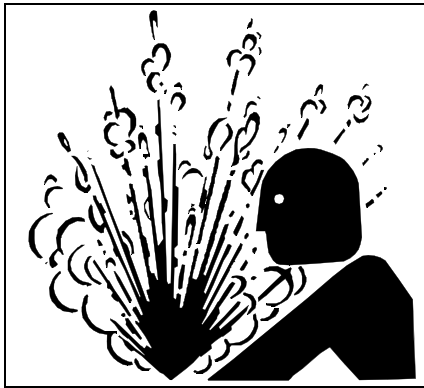

MIF

Explosive release of fluids from pressurized cooling system can cause serious burns.

Shut off machine. Only remove filler cap when cool enough to touch with bare hands. Slowly loosen cap to first stop to relieve pressure before removing completely.

Handle Chemical Products Safely

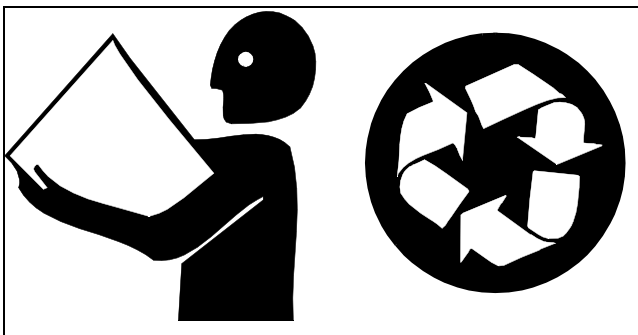

MIF

Direct exposure to hazardous chemicals can cause serious injury. Potentially hazardous chemicals used with John Deere equipment include such items as lubricants, coolants, paints, and adhesives.

A Material Safety Data Sheet (MSDS) provides specific details on chemical products: physical and health hazards, safety procedures, and emergency response techniques. Check the MSDS before you start any job using a hazardous chemical. That way you will know exactly what the risks are and how to do the job safely. Then follow procedures and recommended equipment.

Dispose of Waste Properly

Improperly disposing of waste can threaten the environment and ecology. Potentially harmful waste used with John Deere equipment include such items as oil, fuel, coolant, brake fluid, filters, and batteries. Use leakproof containers when draining fluids. Do not use food or beverage containers that may mislead someone into drinking from them. Do not pour waste onto the ground, down a drain, or into any water source. Inquire on the proper way to recycle or dispose of waste from your local environmental or recycling center, or from your John Deere dealer.

Live With Safety



MIF

Before returning machine to customer, make sure machine is functioning properly, especially the safety systems. Install all guards and shields.

SAFETY



SPECIFICATIONS & INFORMATION TABLE OF CONTENTS

Table of Contents

Fastener Torques	9
Metric Fastener Torque Values	9
Inch Fastener Torque Values	10
O-Ring Seal Service Recommendations	11
Face Seal Fittings With Inch Stud Ends	
Torque	11
Face Seal Fittings With Metric Stud Ends	
Torque	12
O-Ring Face Seal Fittings	13
O-Ring Boss Fittings	13
Straight Fitting or Special Nut Torques	14
Metric Fastener Torque Value - Grade 7 (Special)	14
General Information	14
Gasoline	14
Gasoline Storage.....	15
4 - Cycle Gasoline Engine Oil	15
Break-In Engine Oil - 4-Cycle Gasoline.....	16
Hydrostatic Transmission and Hydraulic Oil.....	16
Gear Case Oil.....	17
Gear Transmission Grease	18
Alternative Lubricants.....	18
Synthetic Lubricants	18
Lubricant Storage	18
Mixing of Lubricants	18
Oil Filters	18
Coolant Specifications	19
Gasoline Engine Coolant.....	19
Gasoline Engine Coolant Drain Interval	19
Serial Number Locations	20
Product Serial Number	20
Gasoline Engine Serial Number Location	20

SPECIFICATIONS & INFORMATION TABLE OF CONTENTS



SPECIFICATIONS & INFORMATION FASTENER TORQUES

Fastener Torques

Metric Fastener Torque Values

Property Class and Head Markings				
Property Class and Nut Markings				

MIF

SIZE	Class 4.8				Class 8.8 or 9.8				Class 10.9				Class 12.9			
	Lubricated a		Dry a		Lubricated a		Dry a		Lubricated a		Dry a		Lubricated a		Dry a	
	N•m	lb-ft	N•m	lb-ft	N•m	lb-ft	N•m	lb-ft	N•m	lb-ft	N•m	lb-ft	N•m	lb-ft	N•m	lb-ft
M6	4.8	3.5	6	4.5	9	6.5	11	8.5	13	9.5	17	12	15	11.5	19	14.5
M8	12	8.5	15	11	22	16	28	20	32	24	40	30	37	28	47	35
M10	23	17	29	21	43	32	55	40	63	47	80	60	75	55	95	70
M12	40	29	50	37	75	55	95	70	110	80	140	105	130	95	165	120
M14	63	47	80	60	120	88	150	110	175	130	225	165	205	150	260	109
M16	100	73	125	92	190	140	240	175	275	200	350	225	320	240	400	300
M18	135	100	175	125	260	195	330	250	375	275	475	350	440	325	560	410
M20	190	140	240	180	375	275	475	350	530	400	675	500	625	460	800	580
M22	260	190	330	250	510	375	650	475	725	540	925	675	850	625	1075	800
M24	330	250	425	310	650	475	825	600	925	675	1150	850	1075	800	1350	1000
M27	490	360	625	450	950	700	1200	875	1350	1000	1700	1250	1600	1150	2000	1500
M30	675	490	850	625	1300	950	1650	1200	1850	1350	2300	1700	2150	1600	2700	2000
M33	900	675	1150	850	1750	1300	2200	1650	2500	1850	3150	2350	2900	2150	3700	2750
M36	1150	850	1450	1075	2250	1650	2850	2100	3200	2350	4050	3000	3750	2750	4750	3500

DO NOT use these hand torque values if a different torque value or tightening procedure is given for a specific application. Torque values listed are for general use only and include a $\pm 10\%$ variance factor. Check tightness of fasteners periodically. DO NOT use air powered wrenches.

Shear bolts are designed to fail under predetermined loads. Always replace shear bolts with identical grade.

Fasteners should be replaced with the same grade. Make sure fastener threads are clean and that you properly start thread engagement. This will prevent them from failing when tightening.

When bolt and nut combination fasteners are used, torque values should be applied to the NUT instead of the bolt head.









Tighten toothed or serrated-type lock nuts to the full torque value.

a "Lubricated" means coated with a lubricant such as engine oil, or fasteners with phosphate and oil coatings. "Dry" means plain or zinc plated (yellow dichromate - Specification JDS117) without any lubrication.

Reference: JDS - G200.

SPECIFICATIONS & INFORMATION FASTENER TORQUES

Inch Fastener Torque Values

SAE Grade and Head Markings	1 or 2 ^b No Marks 	5 5.1 5.2 	8 8.2 
SAE Grade and Nut Markings	2 No Marks 	5  	8  

MIF

SIZE	Grade 1		Grade 2b				Grade 5, 5.1 or 5.2				Grade 8 or 8.2					
	Lubricated a		Dry a		Lubricated a		Dry a		Lubricated a		Dry a		Lubricated a		Dry a	
	N•m	lb-ft	N•m	lb-ft	N•m	lb-ft	N•m	lb-ft	N•m	lb-ft	N•m	lb-ft	N•m	lb-ft	N•m	lb-ft
1/4	3.7	2.8	4.7	3.5	6	4.5	7.5	5.5	9.5	7	12	9	13.5	10	17	12.5
5/16	7.7	5.5	10	7	12	9	15	11	20	15	25	18	28	21	35	26
3/8	14	10	17	13	22	16	27	20	35	26	44	33	50	36	63	46
7/16	22	16	28	20	35	26	44	32	55	41	70	52	80	58	100	75
1/2	33	25	42	31	53	39	67	50	85	63	110	80	120	90	150	115
9/16	48	36	60	45	75	56	95	70	125	90	155	115	175	130	225	160
5/8	67	50	85	62	105	78	135	100	170	125	215	160	215	160	300	225
3/4	120	87	150	110	190	140	240	175	300	225	375	280	425	310	550	400
7/8	190	140	240	175	190	140	240	175	490	360	625	450	700	500	875	650
1	290	210	360	270	290	210	360	270	725	540	925	675	1050	750	1300	975
1-1/8	470	300	510	375	470	300	510	375	900	675	1150	850	1450	1075	1850	1350
1-1/4	570	425	725	530	570	425	725	530	1300	950	1650	1200	2050	1500	2600	1950
1-3/8	750	550	950	700	750	550	950	700	1700	1250	2150	1550	2700	2000	3400	2550
1-1/2	1000	725	1250	925	990	725	1250	930	2250	1650	2850	2100	3600	2650	4550	3350

DO NOT use these hand torque values if a different torque value or tightening procedure is given for a specific application. Torque values listed are for general use only and include a ±10% variance factor. Check tightness of fasteners periodically. DO NOT use air powered wrenches.

Shear bolts are designed to fail under predetermined loads. Always replace shear bolts with identical grade.

Fasteners should be replaced with the same grade. Make sure fastener threads are clean and that you properly start thread engagement. This will prevent them from failing when tightening.

When bolt and nut combination fasteners are used, torque values should be applied to the NUT instead of the bolt

head.

Tighten toothed or serrated-type lock nuts to the full torque value.

a "Lubricated" means coated with a lubricant such as engine oil, or fasteners with phosphate and oil coatings. "Dry" means plain or zinc plated (yellow dichromate - Specification JDS117) without any lubrication.

b "Grade 2" applies for hex cap screws (Not Hex Bolts) up to 152 mm (6 in.) long. "Grade 1" applies for hex cap screws over 152 mm (6 in.) long, and for all other types of bolts and screws of any length.

Reference: JDS - G200

SPECIFICATIONS & INFORMATION O-RING SEAL SERVICE

O-Ring Seal Service Recommendations

Face Seal Fittings With Inch Stud Ends Torque

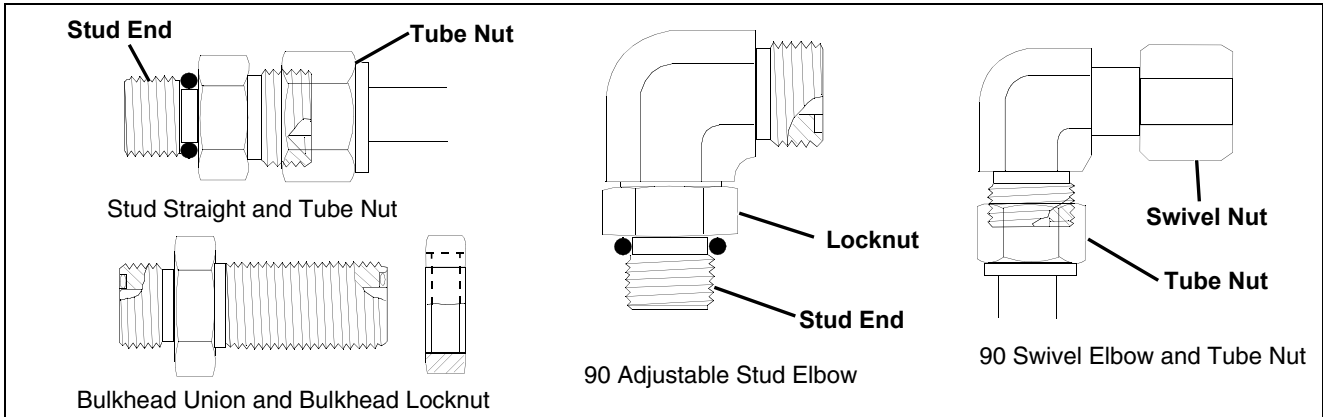

MIF

Nominal Tube OD/Hose ID				Face Seal Tube/Hose End					O-Ring Stud Ends		
Metric Tube OD	Inch Tube OD			Thread Size	Tube Nut/ Swivel Nut Torque		Bulkhead Lock Nut Torque		Thread Size	Straight Fitting or Lock Nut Torque	
	mm	Dash Size	in.		mm	in.	N•m	lb-ft		N•m	lb-ft
5	-3	0.188	4.76						3/8-24	8	6
6	-4	0.250	6.35	9/16-18	16	12	12	9	7/16-20	12	9
8	-5	0.312	7.94						1/2-20	16	12
10	-6	0.375	9.52	11/16-16	24	18	24	18	9/16-18	24	18
12	-8	0.500	12.70	13/16-16	50	37	46	34	3/4-16	46	34
16	-10	0.625	15.88	1-14	69	51	62	46	7/8-14	62	46
19	-12	0.750	19.05	1-3/16-12	102	75	102	75	1-1/16-12	102	75
22	-14	0.875	22.22	1-3/16-12	102	75	102	75	1-3/16-12	122	90
25	-16	1.000	25.40	1-7/16-12	142	105	142	105	1-5/16-12	142	105
32	-20	1.25	31.75	1-11/16-12	190	140	190	140	1-5/8-12	190	140
38	-24	1.50	38.10	2-12	217	160	217	160	1-7/8-12	217	160

NOTE: Torque tolerance is +15%, -20%

SPECIFICATIONS & INFORMATION O-RING SEAL SERVICE

Face Seal Fittings With Metric Stud Ends Torque

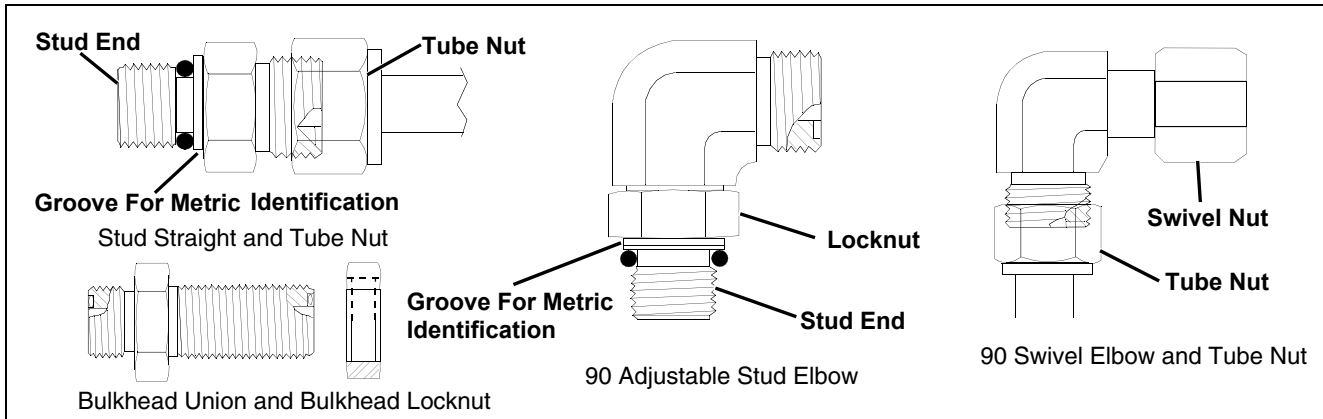

MIF

Nominal Tube OD/Hose ID				Face Seal Tube/Hose End						O-Ring Stud Ends, Straight Fitting or Lock Nut					
Metric Tube OD	Inch Tube OD			Thread Size	Hex Size	Tube Nut/ Swivel Nut Torque		Bulkhead Lock Nut Torque		Thread Size	Hex Size	Steel or Gray Iron Torque		Aluminum Torque	
	Dash Size	in.	mm			in.	mm	N•m	lb-ft			N•m	lb-ft	mm	mm
6	-4	0.250	6.35	9/16-18	17	16	12	12	9	M12X1.5	17	21	15.5	9	6.6
8	-5	0.312	7.94												
										M14X1.5	19	33	24	15	11
10	-6	0.375	9.52	11/16-16	22	24	18	24	18	M16X1.5	22	41	30	18	13
12	-8	0.500	12.70	13/16-16	24	50	37	46	34	M18X1.5	24	50	37	21	15
16	-10	0.625	15.88	1-14	30	69	51	62	46	M22X1.5	27	69	51	28	21
	-12	0.750	19.05	1-3/16-12	36	102	75	102	75	M27X2	32	102	75	46	34
22	-14	0.875	22.22	1-3/16-12	36	102	75	102	75	M30X2	36				
25	-16	1.000	25.40	1-7/16-12	41	142	105	142	105	M33X2	41	158	116	71	52
28										M38X2	46	176	130	79	58
32	-20	1.25	31.75	1-11/16-12	50	190	140	190	140	M42X2	50	190	140	85	63
38	-24	1.50	38.10	2-12	60	217	160	217	160	M48X2	55	217	160	98	72

NOTE: Torque tolerance is +15%, -20%

SPECIFICATIONS & INFORMATION O-RING SEAL SERVICE

O-Ring Face Seal Fittings

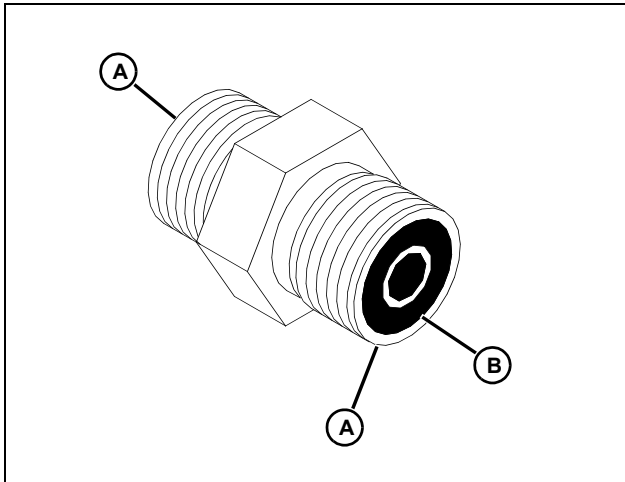

MIF

1. Inspect the fitting sealing surfaces (A). They must be free of dirt or defects.
2. Inspect the O-ring (B). It must be free of damage or defects.
3. Lubricate O-rings and install into groove using petroleum jelly to hold in place during assembly.
4. Index angle fittings and tighten by hand pressing joint together to insure O-ring remains in place.

IMPORTANT: Avoid damage! DO NOT allow hoses to twist when tightening fittings. Use two wrenches to tighten hose connections; one to hold the hose, and the other to tighten the swivel fitting.

5. Tighten fitting or nut to torque value shown on the chart per dash size stamped on the fitting.

O-Ring Boss Fittings

1. Inspect boss O-ring boss seat. It must be free of dirt and defects. If repeated leaks occur, inspect for defects with a magnifying glass. Some raised defects can be removed with a slip stone.

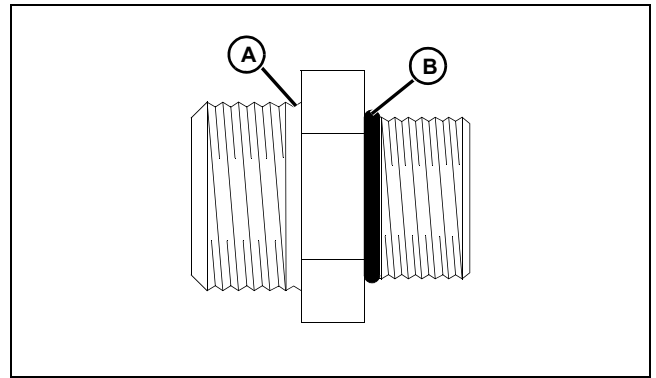

MIF

2. Put hydraulic oil or petroleum jelly on the O-ring (B). Place electrical tape over the threads to protect O-ring from nicks. Slide O-ring over the tape and into the groove (A) of fitting. Remove tape.

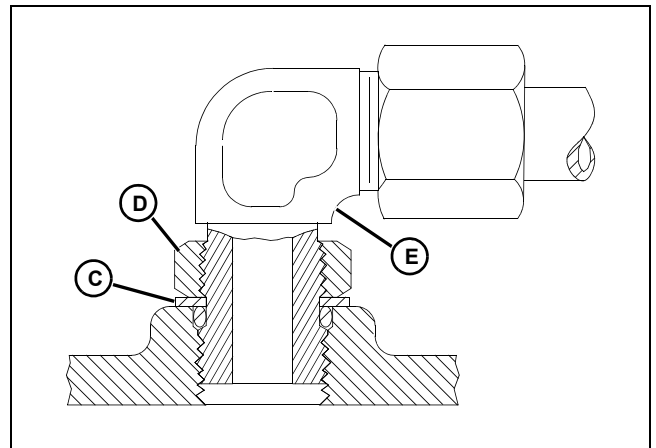

MIF

3. For angle fittings, loosen special nut (D) and push special washer (C) against threads so O-ring can be installed into the groove of fitting.
4. Turn fitting into the boss by hand until special washer or washer face (straight fitting) contacts boss face and O-ring is squeezed into its seat.
5. To position angle fittings (E), turn the fitting counter-clockwise a maximum of one turn.
6. Tighten straight fittings to torque value shown on chart. For angle fittings, tighten the special nut to value shown in the chart while holding body of fitting with a wrench.

SPECIFICATIONS & INFORMATION GENERAL INFORMATION

Straight Fitting or Special Nut Torques

Thread Size	Torque ^a		Number of Flats ^b
	N•m	lb-ft	
3/8-24 UNF	8	6	2
7/16-20 UNF	12	9	2
1/2-20 UNF	16	12	2
9/16-18 UNF	24	18	2
3/4-16 UNF	46	34	2
7/8-14 UNF	62	46	1-1/2
1-1/16-12 UN	102	75	1
1-3/16-12 UN	122	90	1
1-5/16-12 UN	142	105	3/4
1-5/8-12 UN	190	140	3/4
1-7/8-12 UN	217	160	1/2

^aTorque tolerance is \pm 10 percent.

^bTo be used if a torque wrench cannot be used. After tightening fitting by hand, put a mark on nut or boss; then tighten special nut or straight fitting the number of flats shown.

Metric Fastener Torque Value - Grade 7 (Special)

Size	Steel or Gray Iron Torque	Aluminum Torque
	N•m (lb-ft)	N•m (lb-ft)
M6	11 (8)	8 (6)
M8	24 (18)	19 (14)
M10	52 (38)	41 (30)
M12	88 (65)	70 (52)
M14	138 (102)	111 (82)
M16	224 (165)	179 (132)

General Information

Gasoline

4 - Cycle Engines



CAUTION: Avoid Injury! Gasoline is **HIGHLY FLAMMABLE**, handle it with care. **DO NOT** refuel machine while: indoors, always fill gas tank outdoors; machine is near an open flame or sparks; engine is running, **STOP** engine; engine is hot, allow it to cool sufficiently first; smoking. Help prevent fires: fill gas tank to bottom of filler neck only; be sure fill cap is tight after fueling; clean up any gas spills **IMMEDIATELY**; keep machine clean and in good repair - free of excess grease, oil, debris, and faulty or damaged parts; any storage of machines with gas left in tank should be in an area that is well ventilated to prevent possible igniting of fumes by an open flame or spark, this includes any appliance with a pilot light. To prevent fire or explosion caused by **STATIC ELECTRIC DISCHARGE** during fueling: **ONLY** use a clean, approved **POLYETHYLENE PLASTIC** fuel container and funnel **WITHOUT** any metal screen or filter.

To avoid engine damage:

- DO NOT mix oil with gasoline;
- **ONLY** use clean, fresh unleaded gasoline with an octane rating (anti-knock index) of 87 or higher;
- fill gas tank at the end of each day's operation to help prevent condensation from forming inside a partially filled tank;
- keep up with specified service intervals.

Use of alternative oxygenated, gasohol blended, unleaded gasoline is acceptable as long as:

- the ethyl or grain alcohol blends DO NOT exceed 10% by volume or
- methyl tertiary butyl ether (MTBE) blends DO NOT exceed 15% by volume

RFG (reformulated) gasoline is acceptable for all machines designed for use of regular unleaded fuel. Older machines (that were designed for leaded fuel) may see some accelerated valve and seat wear.

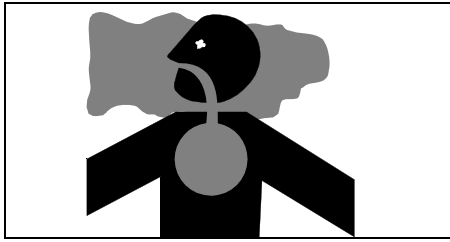

MIF

IMPORTANT: Avoid damage! California Proposition 65 Warning: Gasoline engine exhaust from this product contains chemicals known to the State of California to cause cancer, birth defects, or other reproductive harm.

Gasoline Storage

IMPORTANT: Avoid damage! Keep all dirt, scale, water or other foreign material out of gasoline.

Keep gasoline stored in a safe, protected area. Storage of gasoline in a clean, properly marked ("UNLEADED GASOLINE") POLYETHYLENE PLASTIC container WITHOUT any metal screen or filter is recommended. DO NOT use de-icers to attempt to remove water from gasoline or depend on fuel filters to remove water from gasoline. Use a water separator installed in the storage tank outlet. BE SURE to properly discard unstable or contaminated gasoline. When storing the machine or gasoline, it is recommended that you add **John Deere Gasoline Conditioner and Stabilizer (TY15977)** or an equivalent to the gasoline. BE SURE to follow directions on container and to properly discard empty container.

4 - Cycle Gasoline Engine Oil

Use the appropriate oil viscosity based on the expected air temperature range during the period between recommended oil changes. Operating outside of these recommended oil air temperature ranges may cause premature engine failure.

The following John Deere oils are PREFERRED:

- **PLUS - 4® - SAE 10W-40;**
- **TORQ - GARD SUPREME® - SAE 5W-30.**

The following John Deere oils are **also recommended**, based on their specified temperature range:

- **TURF - GARD® - SAE 10W-30;**
- **PLUS - 4® - SAE 10W-30;**
- **TORQ - GARD SUPREME® - SAE 30.**

Other oils may be used if above John Deere oils are not available, provided they meet one of the following specifications:

- SAE 10W-40 - API Service Classifications SG or higher;
- SAE 5W-30 - API Service Classification SG or higher;
- SAE 10W-30 - API Service Classifications SG or higher;
- SAE 30 - API Service Classification SC or higher.

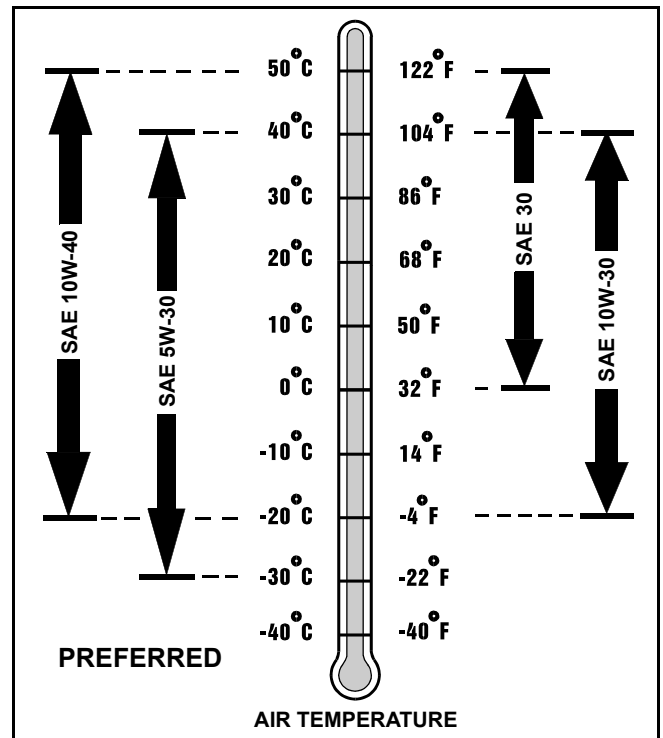

MIF

Please click here and go
back to our website.

BUY NOW

Then Instant Download the
Complete Manual.

Thank you very much!